

IMPORTANT INFORMATION

SAFETY & RESPONSIBILITY

The operator of any tools should be skilled and familiar with the correct use of each tool. Proper safety gear must always be worn. It is the responsibility of the installer to ensure local building code(s) are followed. If the installer is uncertain, they should consult a local official to be certain.

RECOMMENDED TOOLS:

Miter Saw	and/or	Circular Saw	and/or	Table Saw
Finishing Blade		Drill w/ #2 Square Drill Bits		Rubber Mallet
Measuring Tape		Pencil/Marker		Level
Caulking Gun		Construction Adhesive		2P-10 Adhesive
(Needle Nose) Pliers		Utility Knife		Fine Sandpaper
Safety Glasses		Earplugs		Dust Mask

PRODUCT COLORING:

One of the great things about LANAI is the beautiful variation in colour tones in each Plank and between different Planks. It is very important to open as many bundles as possible and lay the Planks out ensure the varying colors are evenly distributed to achieve the desired look. It is also important to note that the all boards should be used only with the grain side up. The bottom edge is very smooth and shiny and could be dangerous when wet.

CUTTING:

All cuts should be done with a finishing blade. The number of teeth will depend on the size of the blade.

PRODUCT SUMMARY:

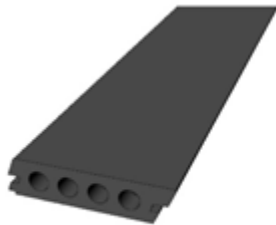

DECK PLANK
(48"x4"x1")



NARROW PLANK
(48"x2"x1")



DECK NOSING
(48"x3"x1")



HIDDEN PLANK
FASTENER

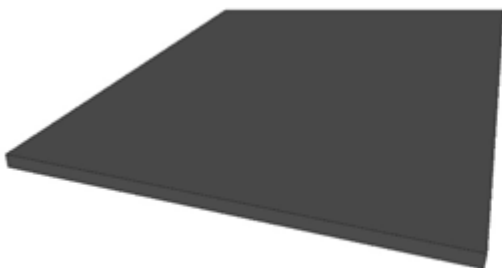

DECK FASCIA
(48"x12"x1/4")

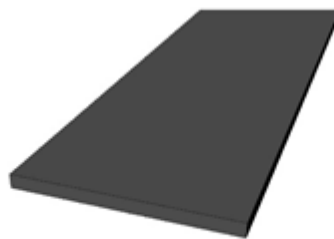

DECK RISER
(48"x7.25"x1/4")



HIDDEN NOSING
FASTENER



(FIT) FIRST-ROW
INSTALL TOOL

For more information, please visit our website or contact us:

www.lanaioutdoors.com * Toll Free at 1-877-477-4373 * Email at hello@lanaioutdoors.com

DECK FRAMING:

It is important to locate and follow standard deck framing methods that adhere to your local building codes.

LANAI requires a doubled rim joist around the perimeter. This is needed for the installation of the *Hidden Nosing Fasteners*, which are the starting point of the deck installation. When installing LANAI Premium Plank Decking in a non-covered environment, the decking structure should be slightly sloped to help allow for proper drainage. Joists should be sloped 1/8" per foot away from the house to facilitate drainage. Refer to your local building code official for recommendations BEFORE building sub-structure.

Although LANAI is engineered to span 16" on center joisting, we highly recommend 12" centers. This provides both additional strength, as well as four staggered Plank lengths. All framing should be completed with pressure-treated lumber and required fasteners.

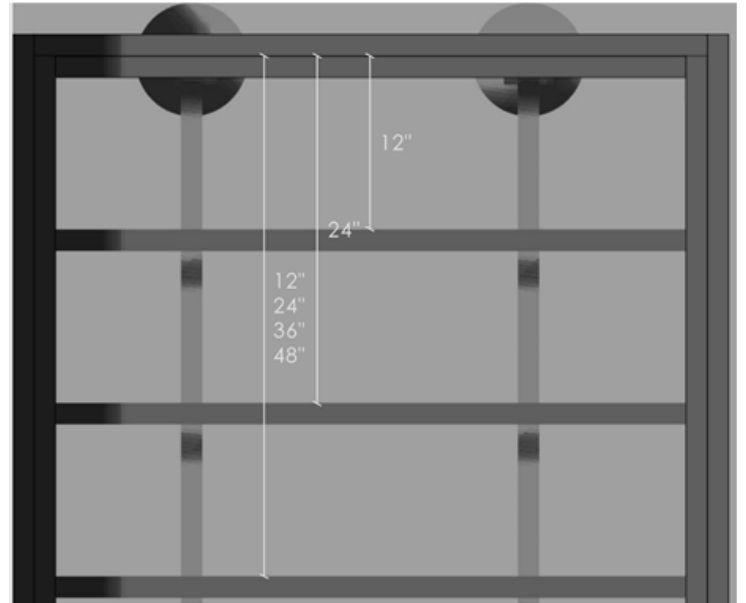
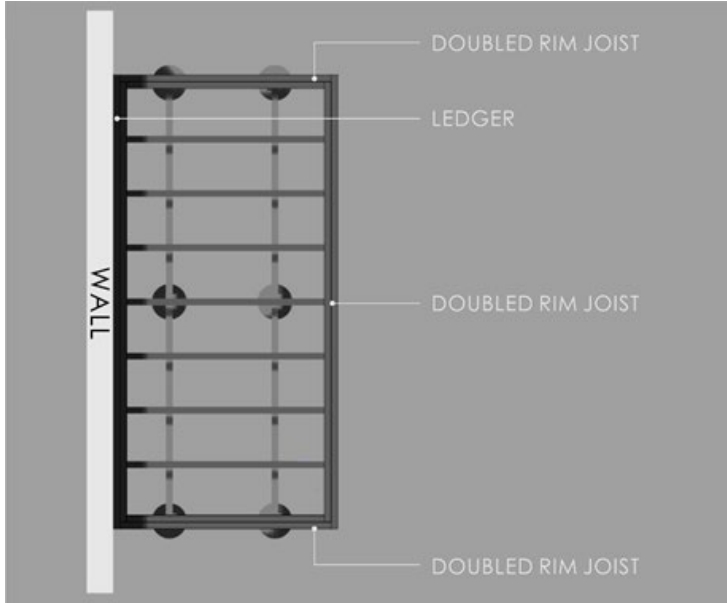

For more information, please visit our website or contact us:

www.lanaioutdoors.com * Toll Free at 1-877-477-4373 * Email at hello@lanaioutdoors.com

GETTING STARTED

For the LANAI Premium Plank Decking system to be installed most effectively, we recommend starting at the **End Joist**, which is the furthest point perpendicular from the wall of the house/building. You will then work towards the wall. This way if any *Deck Planks* need to be cut to fit, the cut side will be hidden against the wall.

In most cases, the first course is always going to consist of *Deck Nosing*.

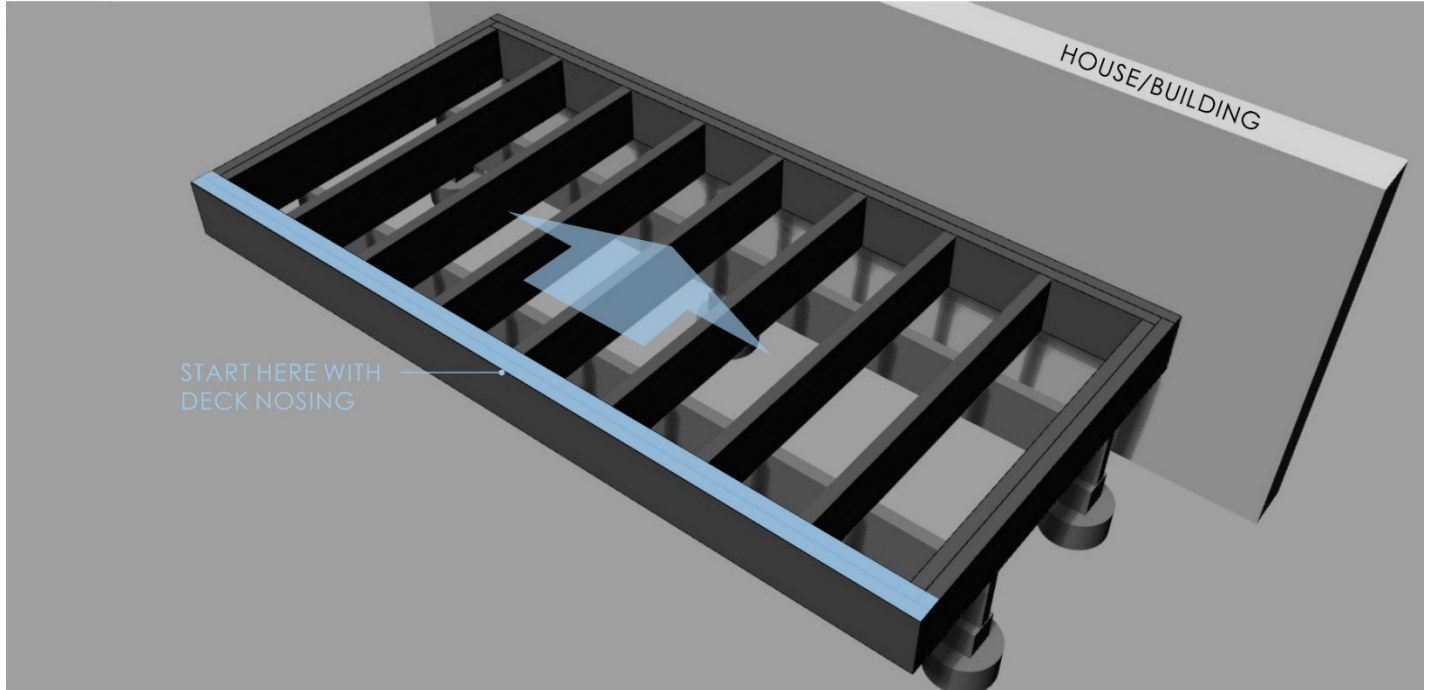

The only time the first course should be *Deck Planks* is when LANAI is being installed between two walls (as per below).

In this situation *Deck Planks* would be installed from wall to wall, or a 'picture frame' install can be done using only *Deck Planks*.

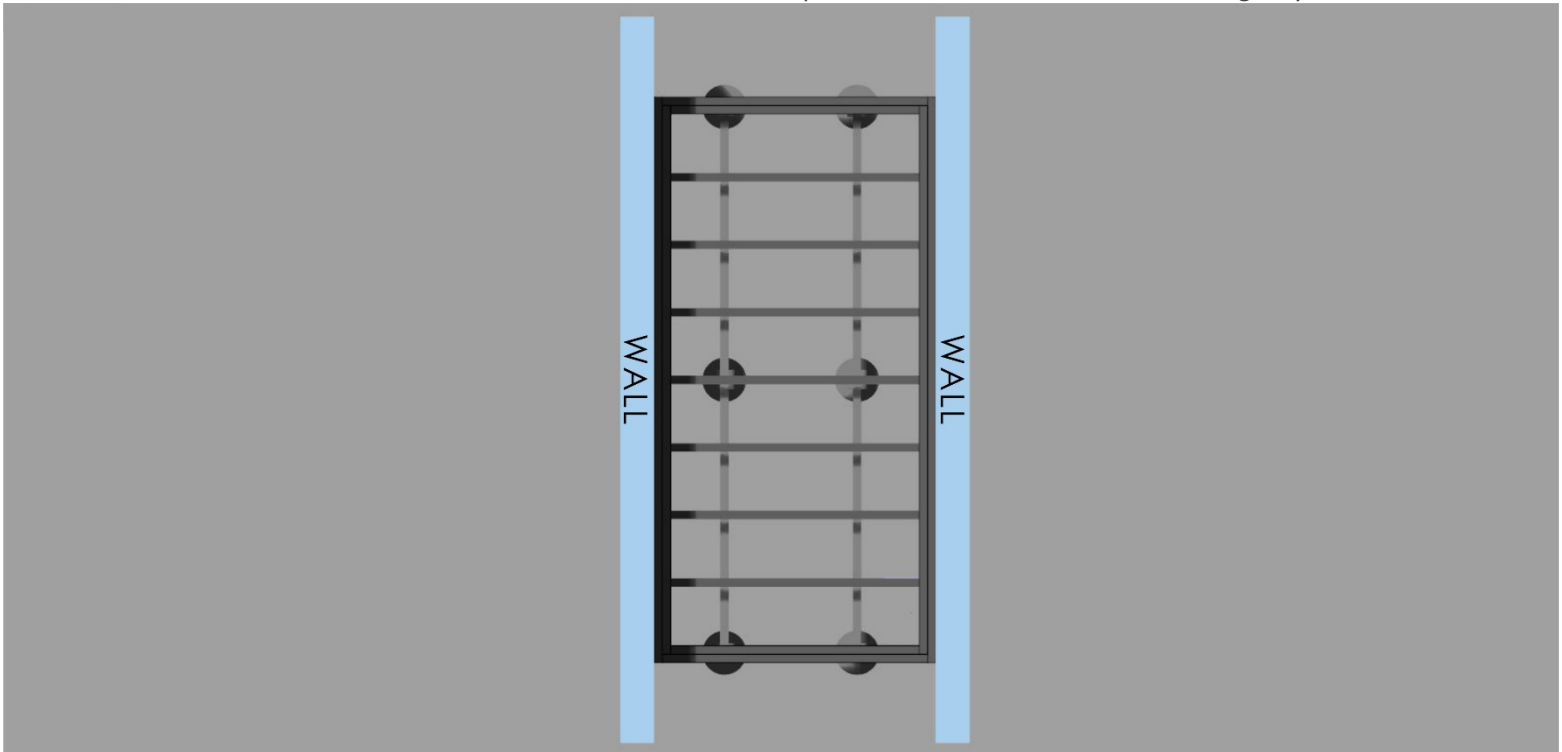

For more information, please visit our website or contact us:

www.lanaioutdoors.com * Toll Free at 1-877-477-4373 * Email at hello@lanaioutdoors.com

INSTALLING THE PERIMETER DECK NOSING

1. Hidden Nosing Fastener Installation:

First attach the *Hidden Nosing Fasteners* along the **Outer End Joist**. The 'bridge' of the *Hidden Nosing Fasteners* should be on the **Outer End Joist**. The etched line on the *Hidden Nosing Fastener* should be in-line with the line between the two **End Joists**.

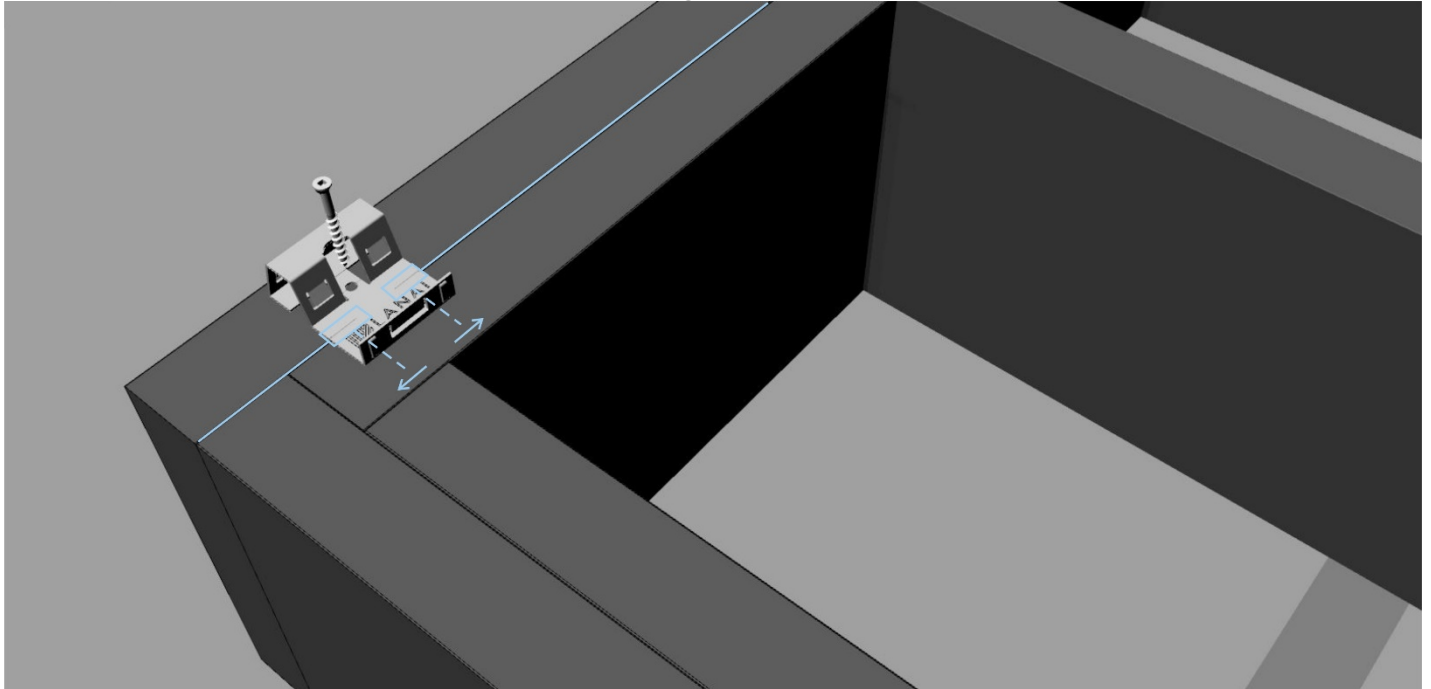

Begin by installing the first *Hidden Nosing Fastener* 2 ¼" from the outer edge of the **Outer Side Joist**.

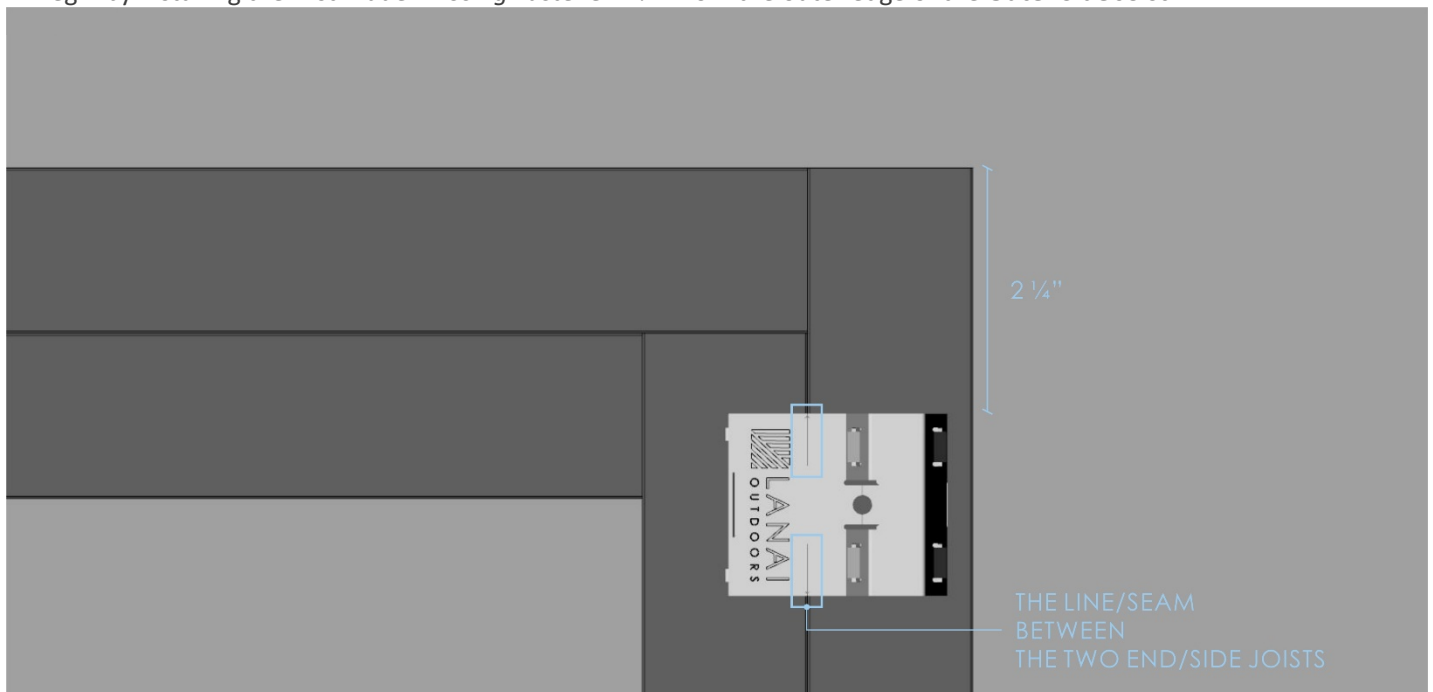

For more information, please visit our website or contact us:

www.lanaioutdoors.com * Toll Free at 1-877-477-4373 * Email at hello@lanaioutdoors.com

Next install *Hidden Nosing Fasteners* every 14 ½" after that.

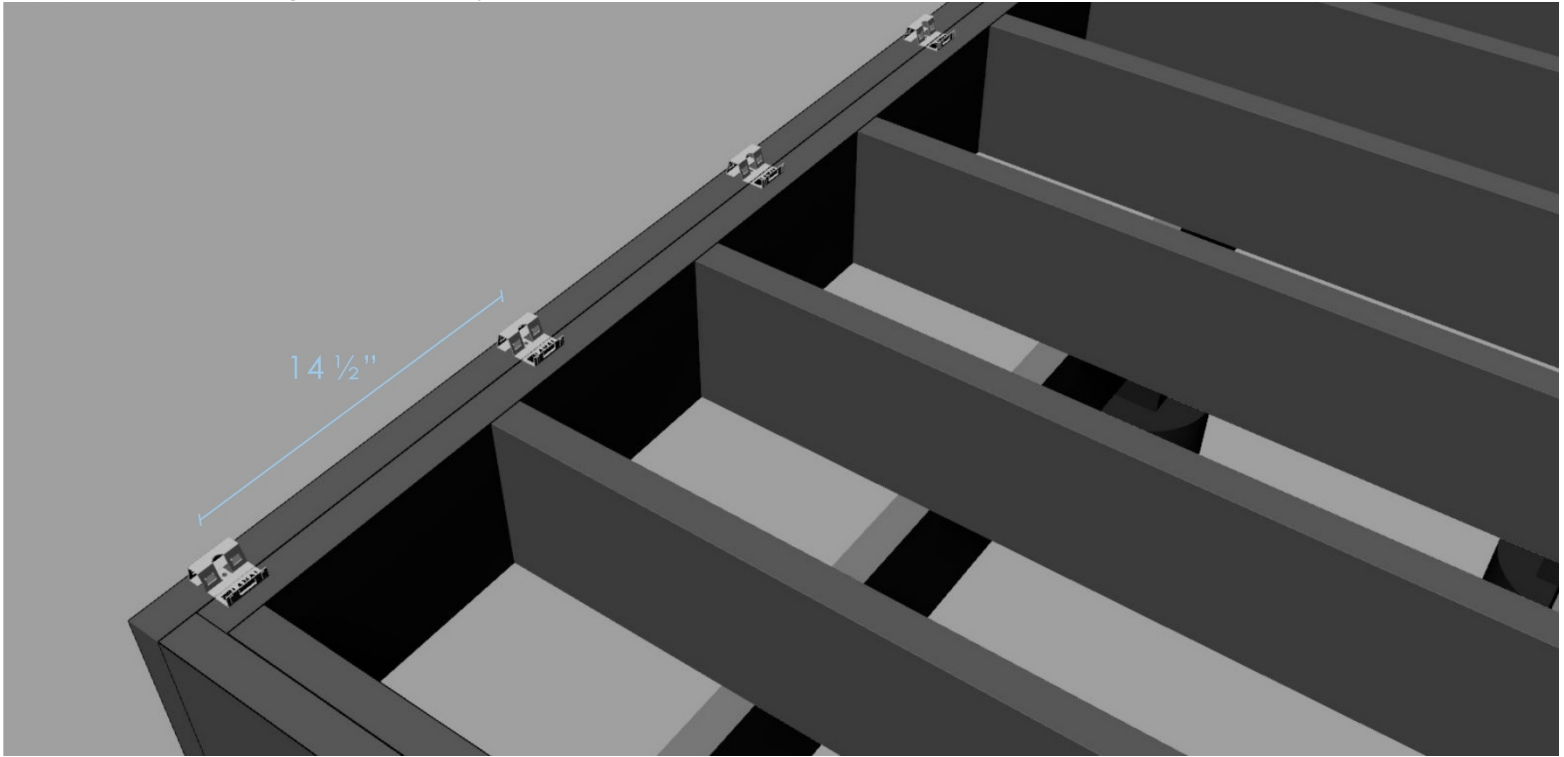

The final *Hidden Nosing Fastener* may need to be less than 14 ½", as it should be 2 ¼" from the far edge of the opposite **Outer Side Joist**.

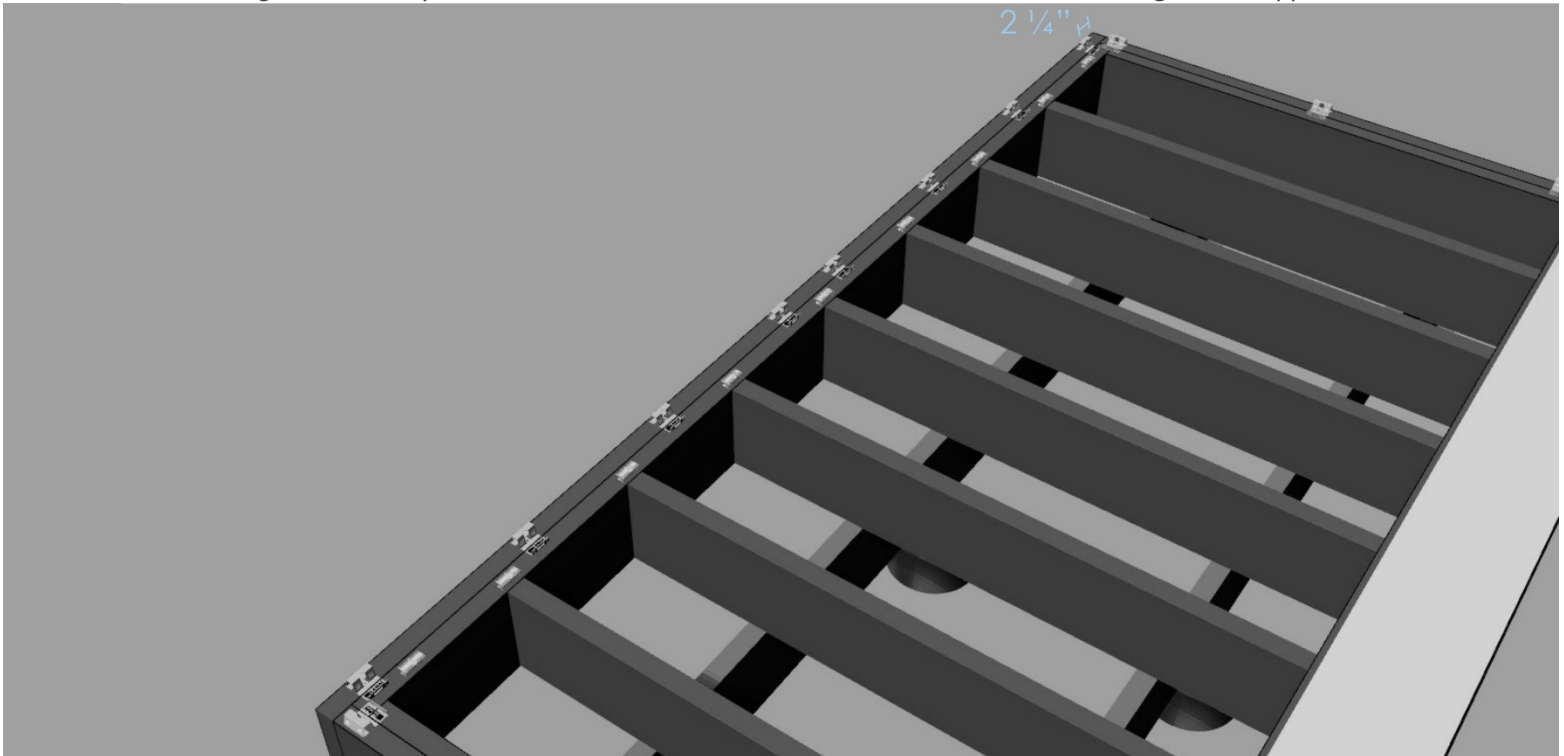

For more information, please visit our website or contact us:

www.lanaioutdoors.com * Toll Free at 1-877-477-4373 * Email at hello@lanaioutdoors.com

Next install the *Hidden Nosing Fasteners* down each **Outer Side Joist** about 48".

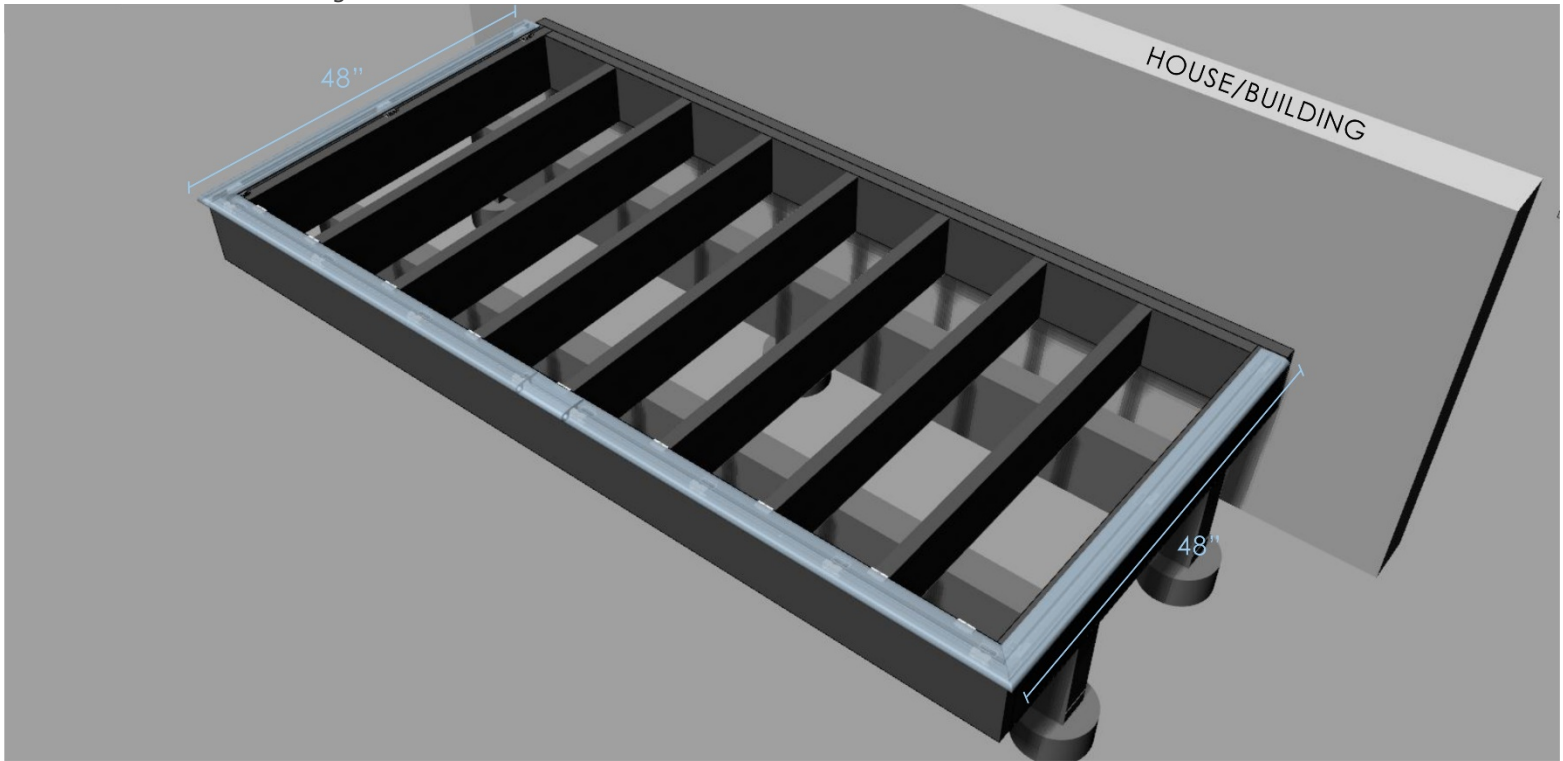

Again, install the first *Hidden Nosing Fastener* 2 ¼" from the outer edge of the **Outer Side Joist** and then every 14 ½" after that.

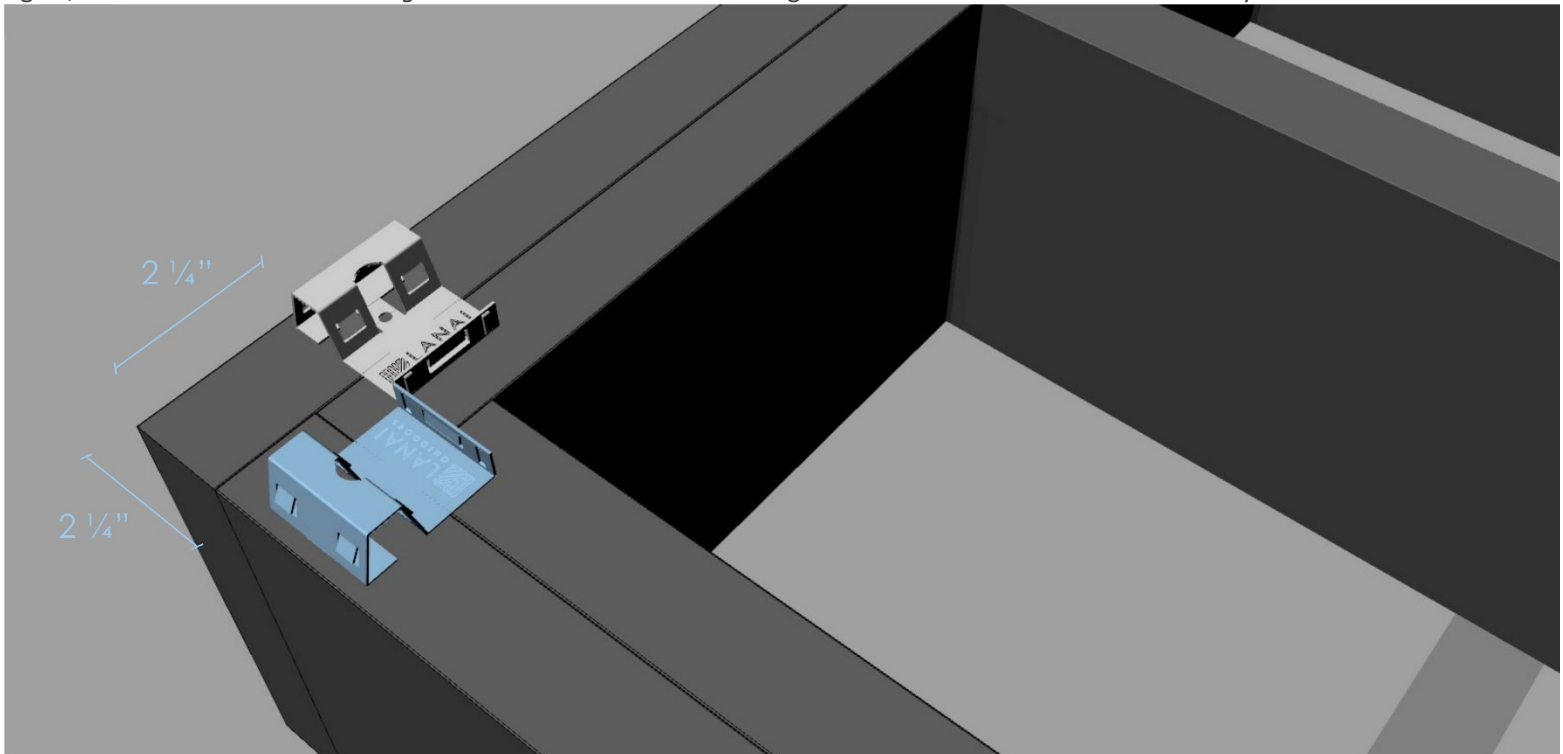

For more information, please visit our website or contact us:

www.lanaioutdoors.com * Toll Free at 1-877-477-4373 * Email at hello@lanaioutdoors.com

2. Hidden Plank Fastener Installation:

For the first row of *Deck Nosing* only, the *Hidden Plank Fasteners* will need to be installed before installing the *Deck Nosing*.

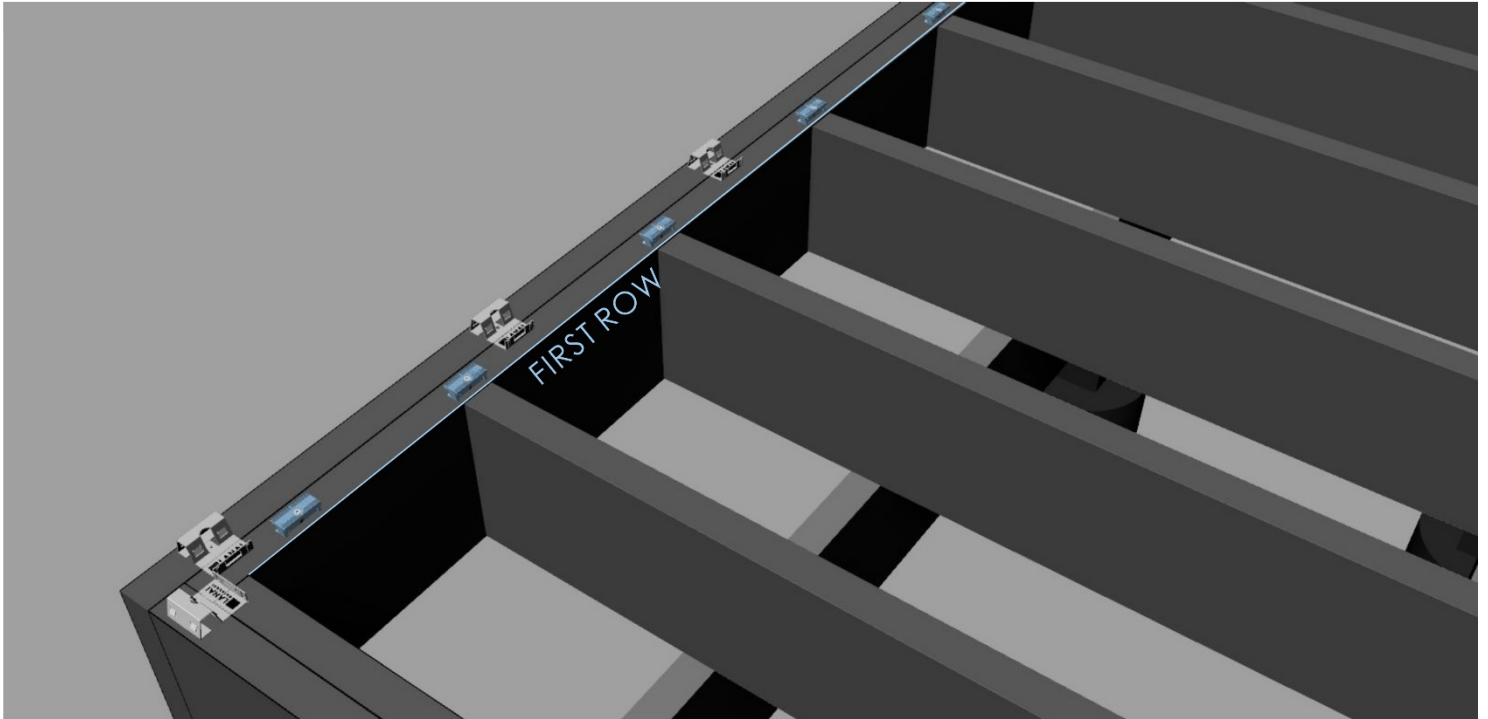

Position the First-row Install Tool (FIT) against the inside edge of the **Inner End Joist**, directly beside the first *Hidden Nosing Fastener*. First row only - both joist-wings on the *Hidden Plank Fasteners* will need to be removed. These are easily snapped off with pliers.

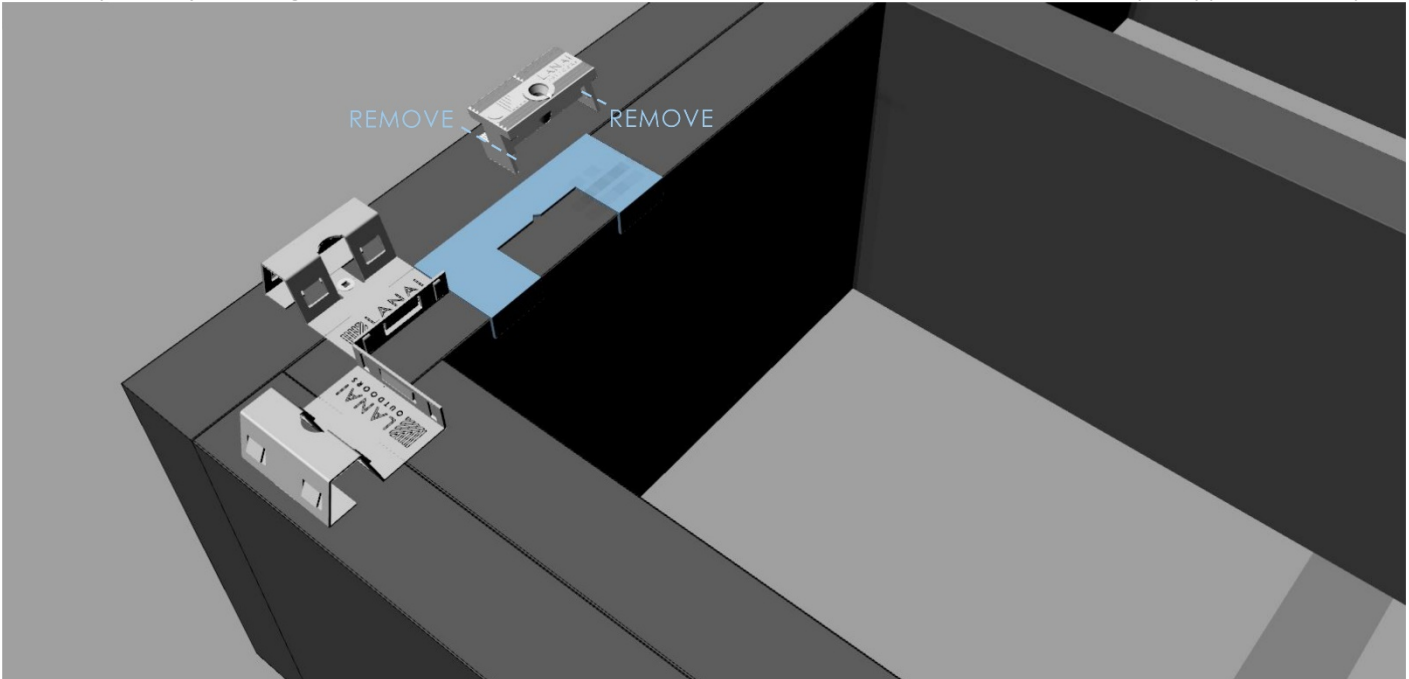

For more information, please visit our website or contact us:

www.lanaioutdoors.com * Toll Free at 1-877-477-4373 * Email at hello@lanaioutdoors.com

Place *Hidden Plank Fastener* into the FIT, making sure it is facing in the correct direction (LANAI logo should be facing same direction as the *Hidden Nosing Fasteners*, as per the diagram below). Secure by driving the screw into the joist until flush with the top of the *Hidden Plank Fastener*.

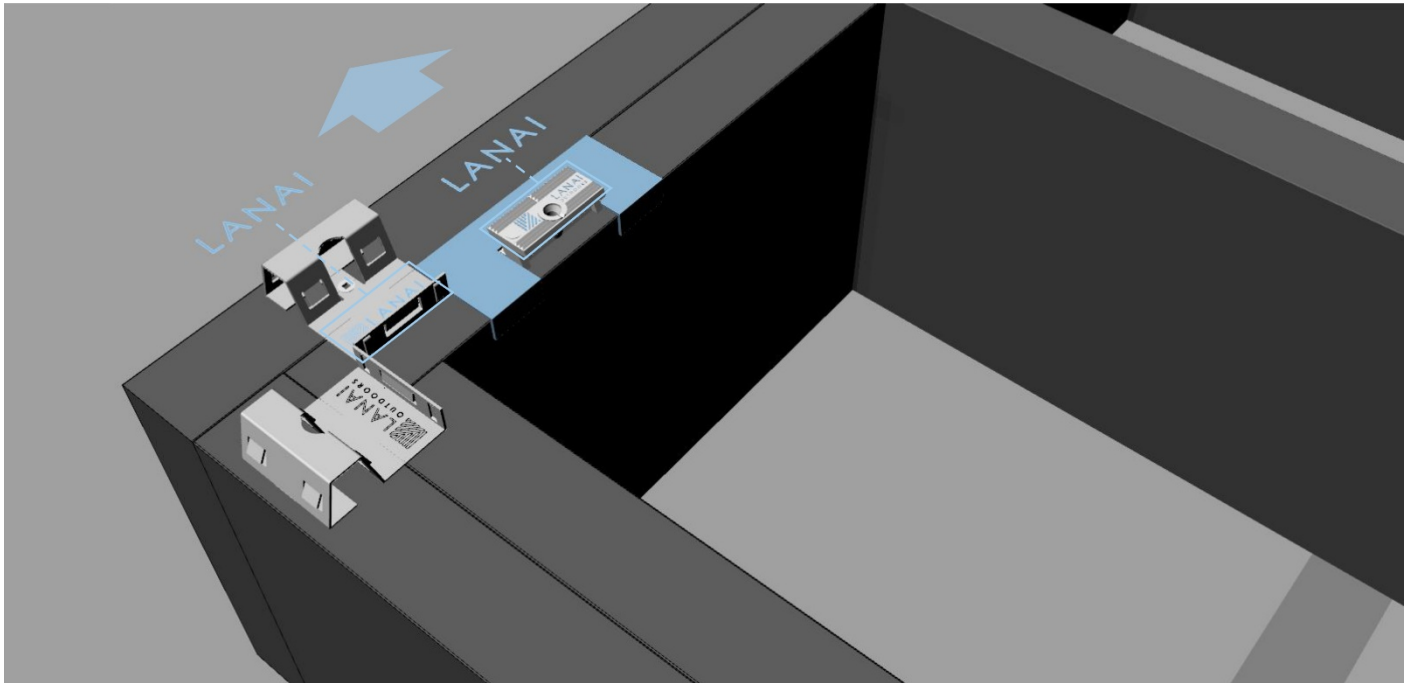

If you do not have the FIT tool, you can still measure and install the *Hidden Plank Fasteners*. Measure and install *Hidden Plank Fasteners* 2 ¼" from the outside edge of the **Outer End Joist**, or ¼" in from the inside edge of the **Inner End Joist**.

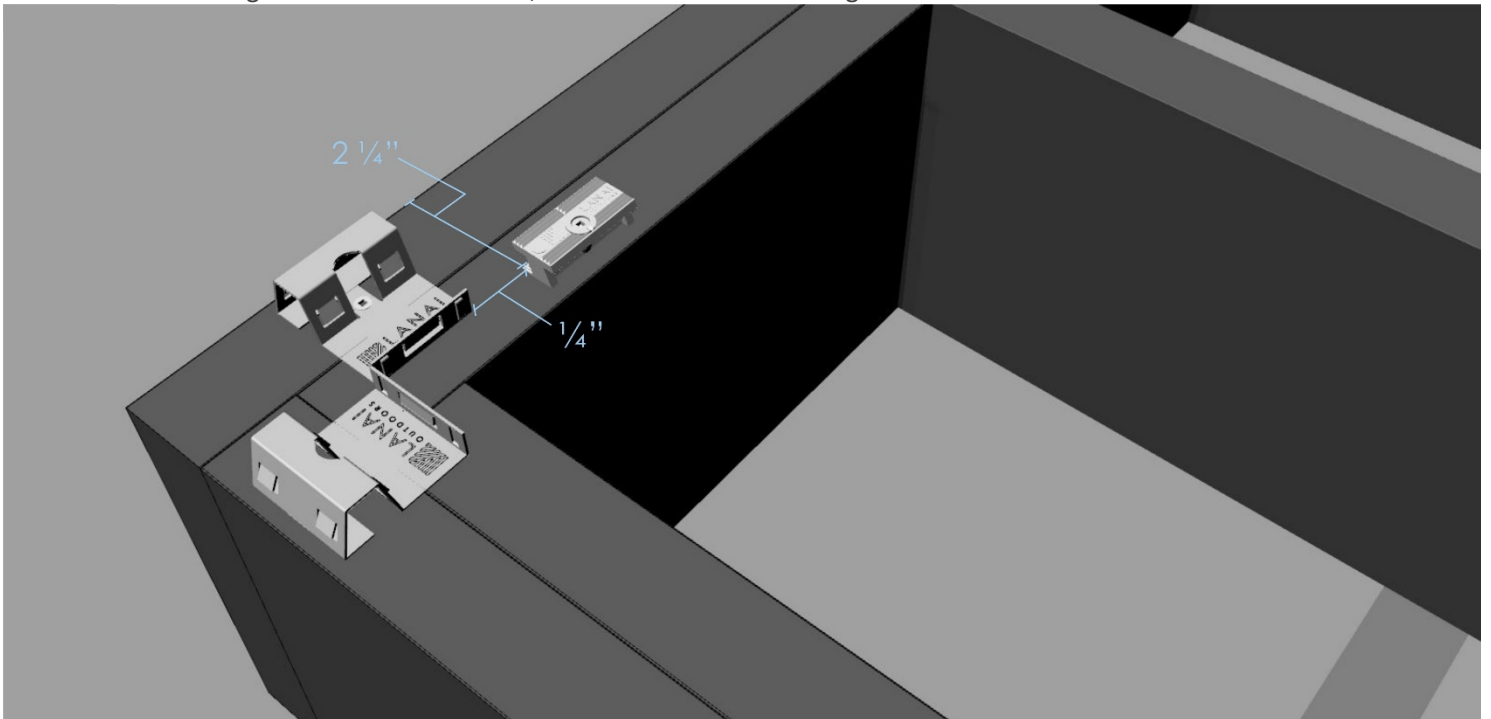

For more information, please visit our website or contact us:

www.lanaioutdoors.com * Toll Free at 1-877-477-4373 * Email at hello@lanaioutdoors.com

Next place *Hidden Plank Fasteners* centered in line with every joist that hits perpendicular to the **Inner Joist**.

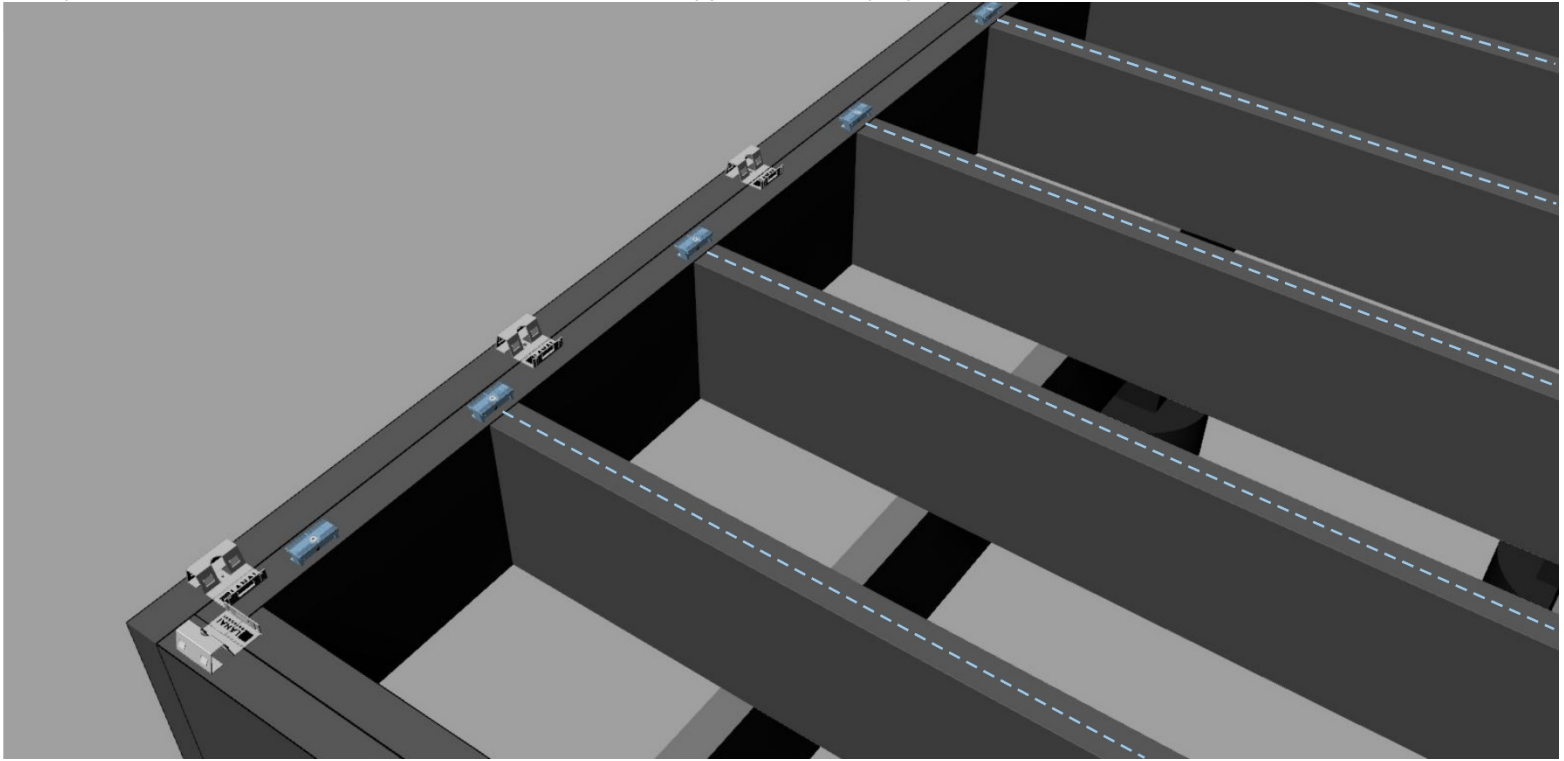

Deck Nosing Installation:

PRO TIP: Install smaller pieces of Deck Nosing at the corners, as the smaller the piece the less likely it is for the miter seam to 'open up' or have a gap over time. We recommend cutting the miter in the middle of a *Deck Nosing*, creating two approx. 24" corner pieces.

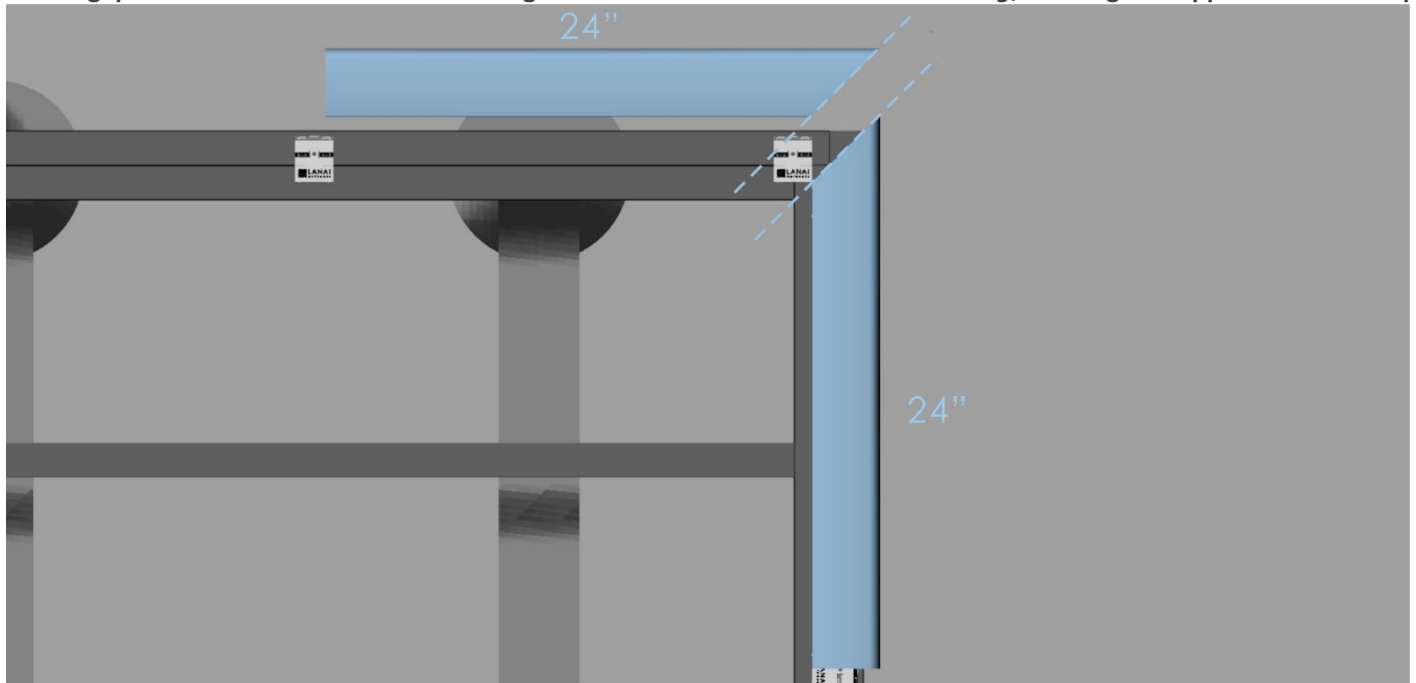

For more information, please visit our website or contact us:

www.lanaioutdoors.com * Toll Free at 1-877-477-4373 * Email at hello@lanaioutdoors.com

Using a saw with a fine-toothed blade, begin by mitering (at a 45-degree angle) your first *Deck Nosing*.

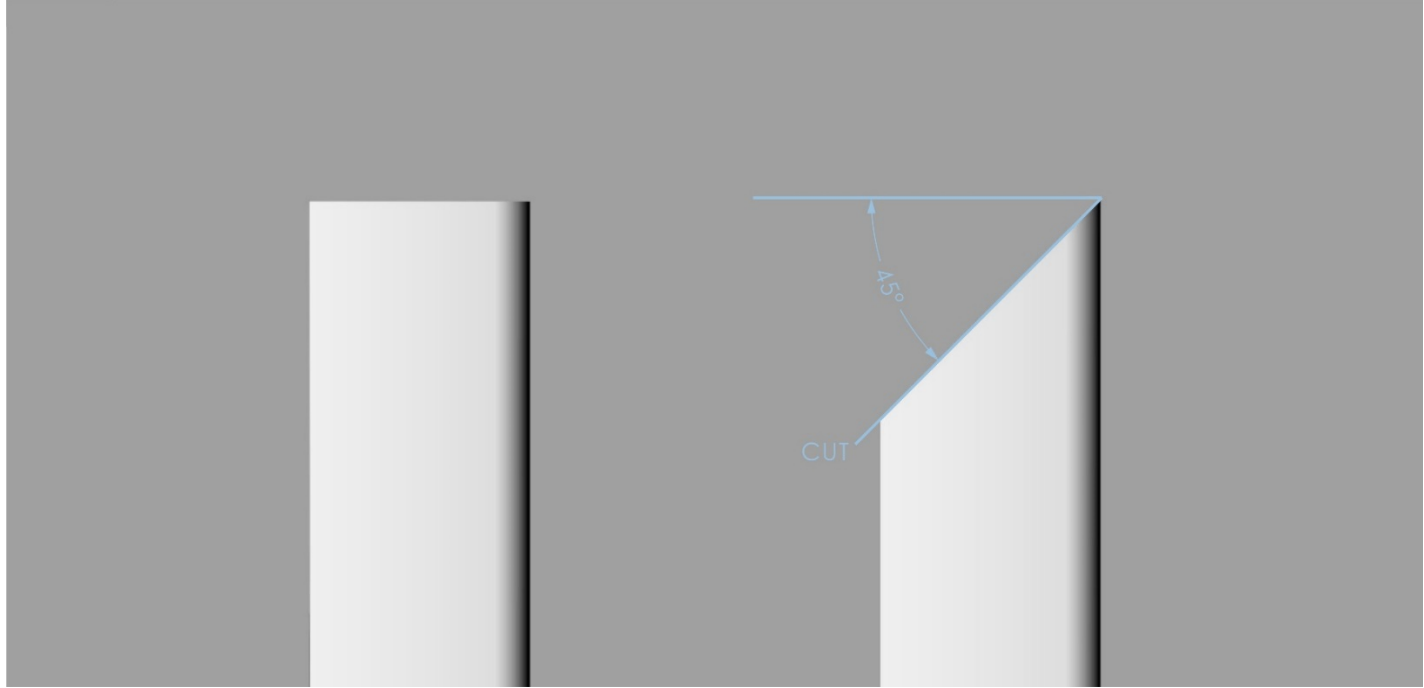

Then place the *Deck Nosing* so the miter lines up perfectly with the corner of the **Outer End Joist**.

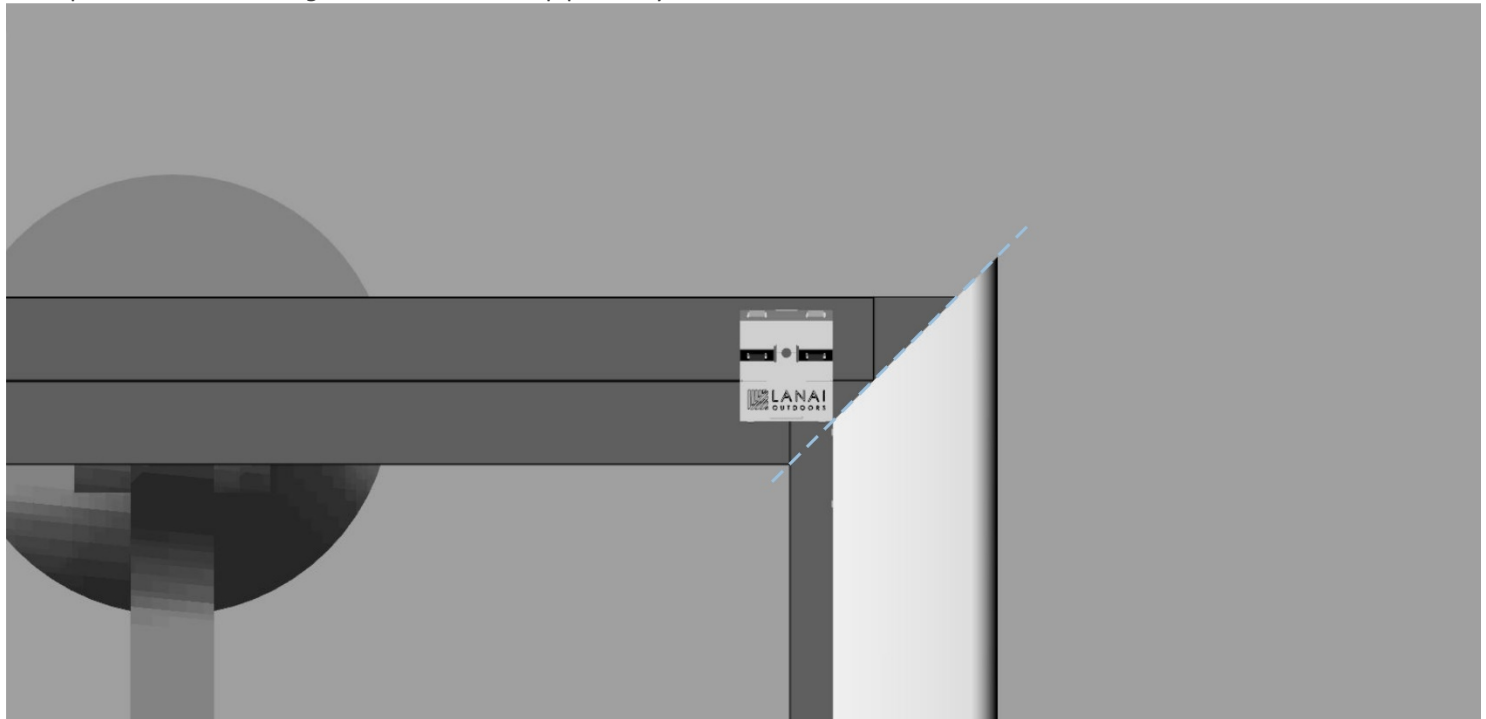

For more information, please visit our website or contact us:

www.lanaioutdoors.com * Toll Free at 1-877-477-4373 * Email at hello@lanaioutdoors.com

Ensure the bridge of the *Nosing Plank Fastener* is directly under the matching bridge in the *Deck Nosing*.

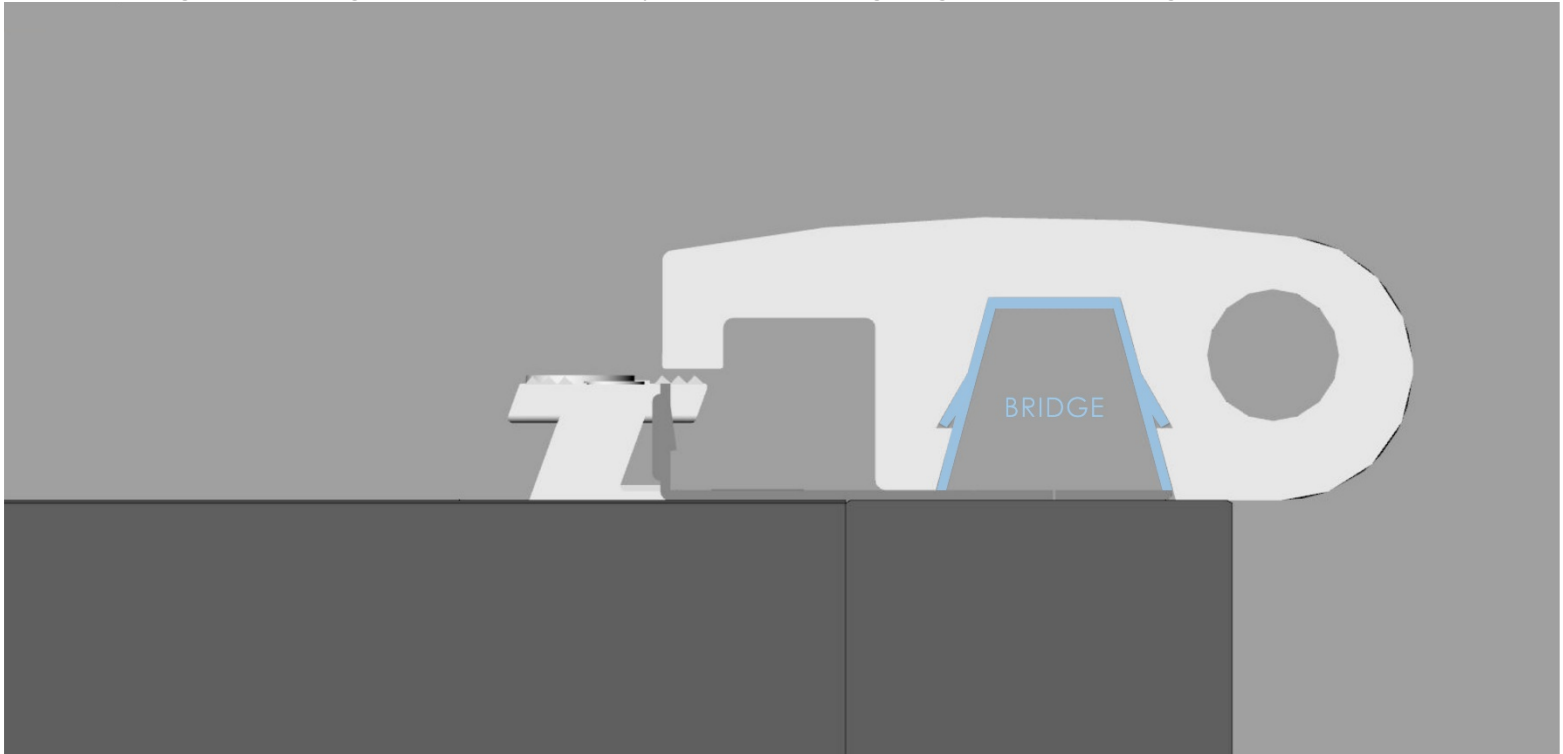

Once it is properly aligned, lightly tap down into place using a rubber mallet.

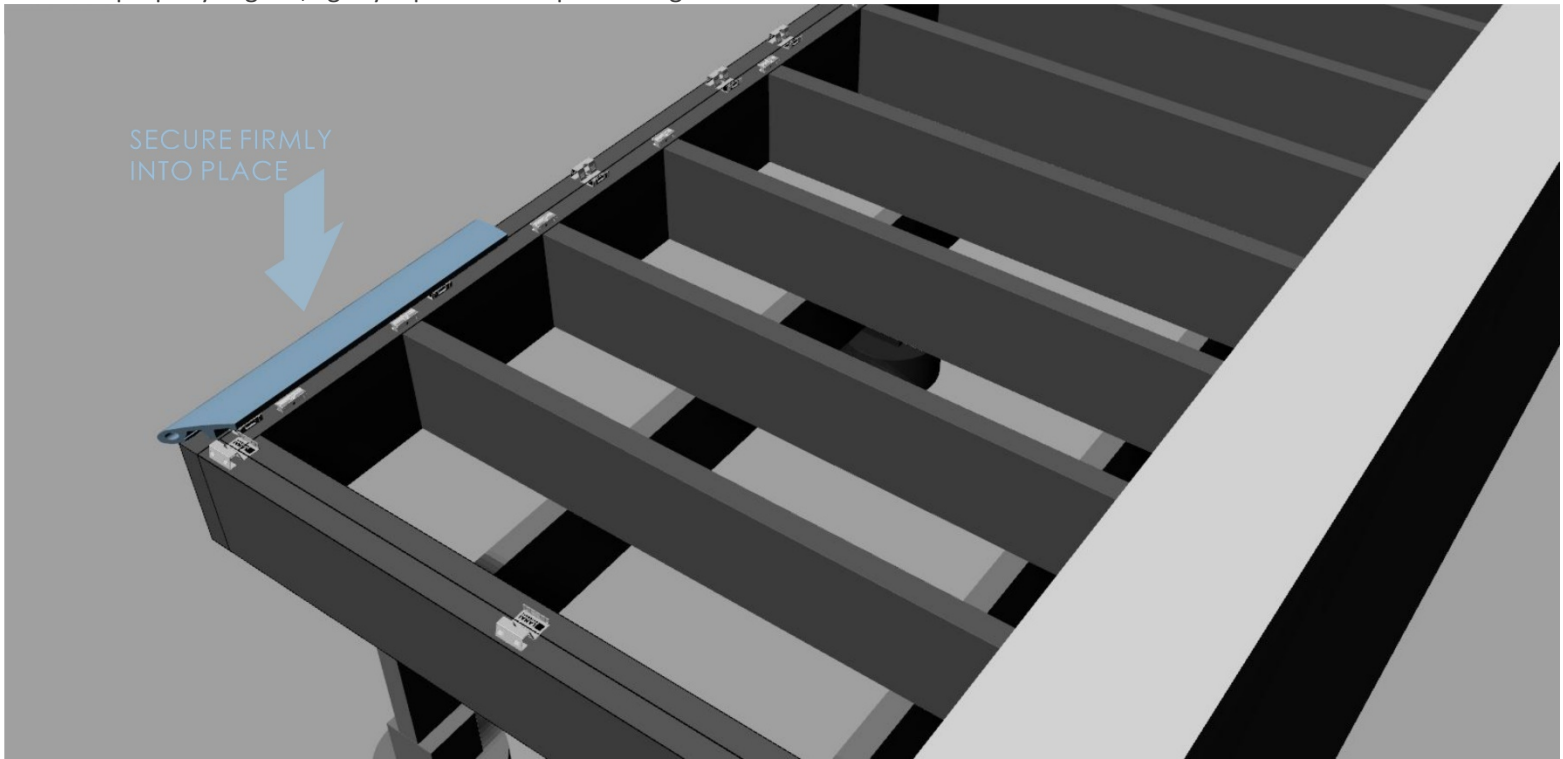

For more information, please visit our website or contact us:

www.lanaioutdoors.com * Toll Free at 1-877-477-4373 * Email at hello@lanaioutdoors.com

PRO TIP: The rubber mallet can also be used to gently adjust the lateral placement of the *Deck Nosing* if necessary.

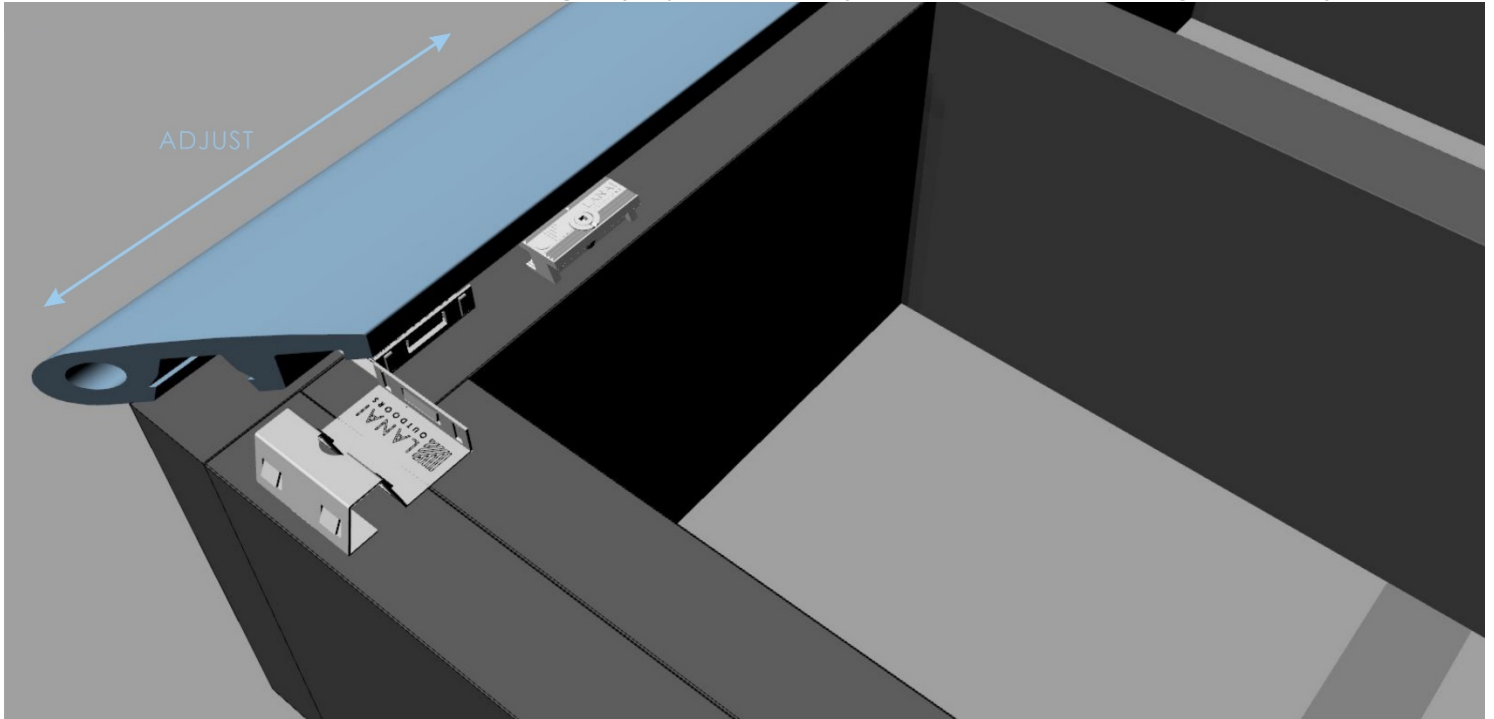

Continue installing *Deck Nosing* until there is less than 48" from outside edge of the Outer Side Joist. It is best to leave a very small gap (approx. 1/32") between each *Deck Nosing* to allow for some minor expansion. Measure and miter-cut the final piece in that row 45-degrees.

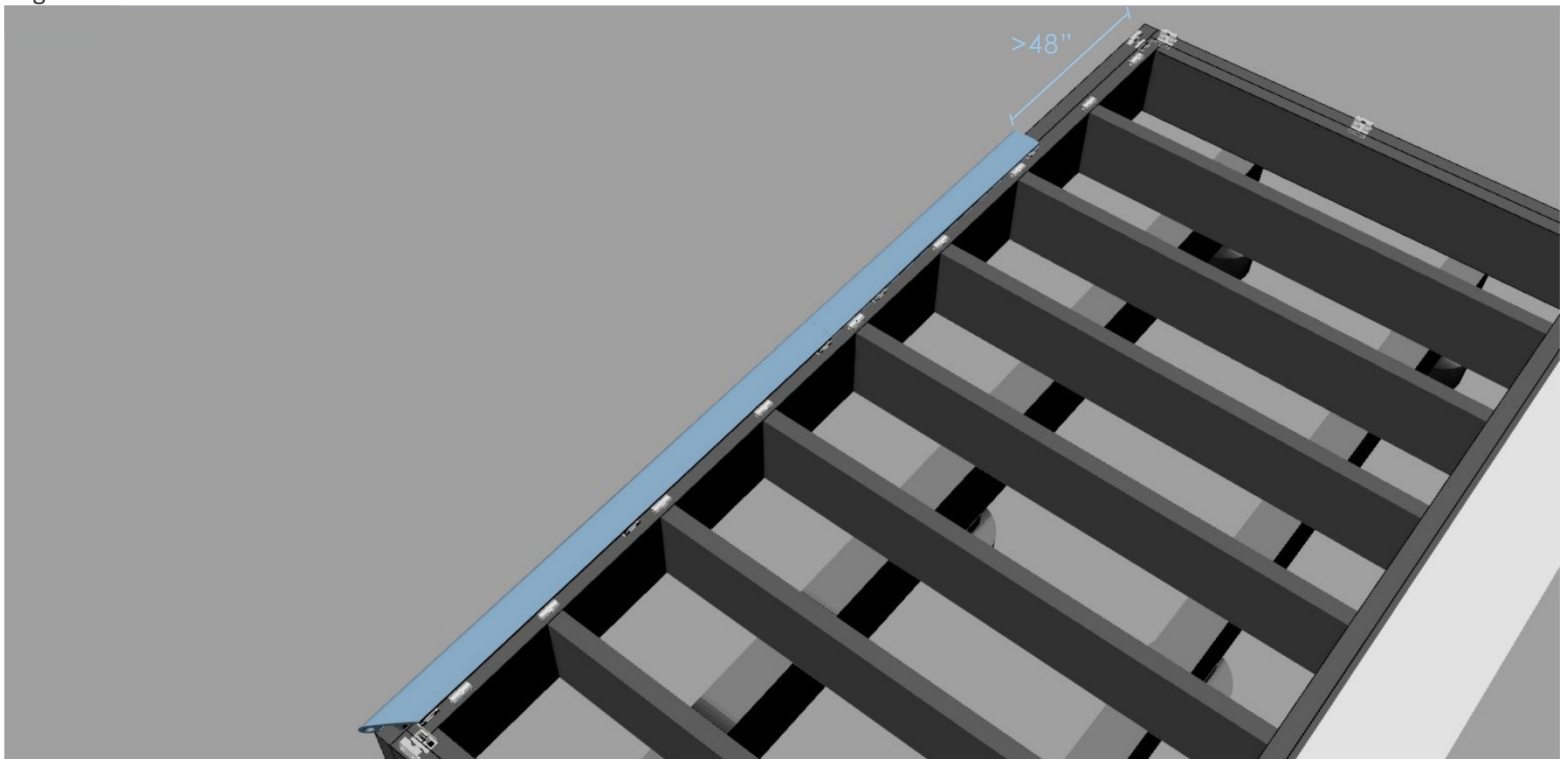

For more information, please visit our website or contact us:

www.lanaioutdoors.com * Toll Free at 1-877-477-4373 * Email at hello@lanaioutdoors.com

3. Next, cut a 48" *Deck Nosing* at an opposite 45-degree miter.

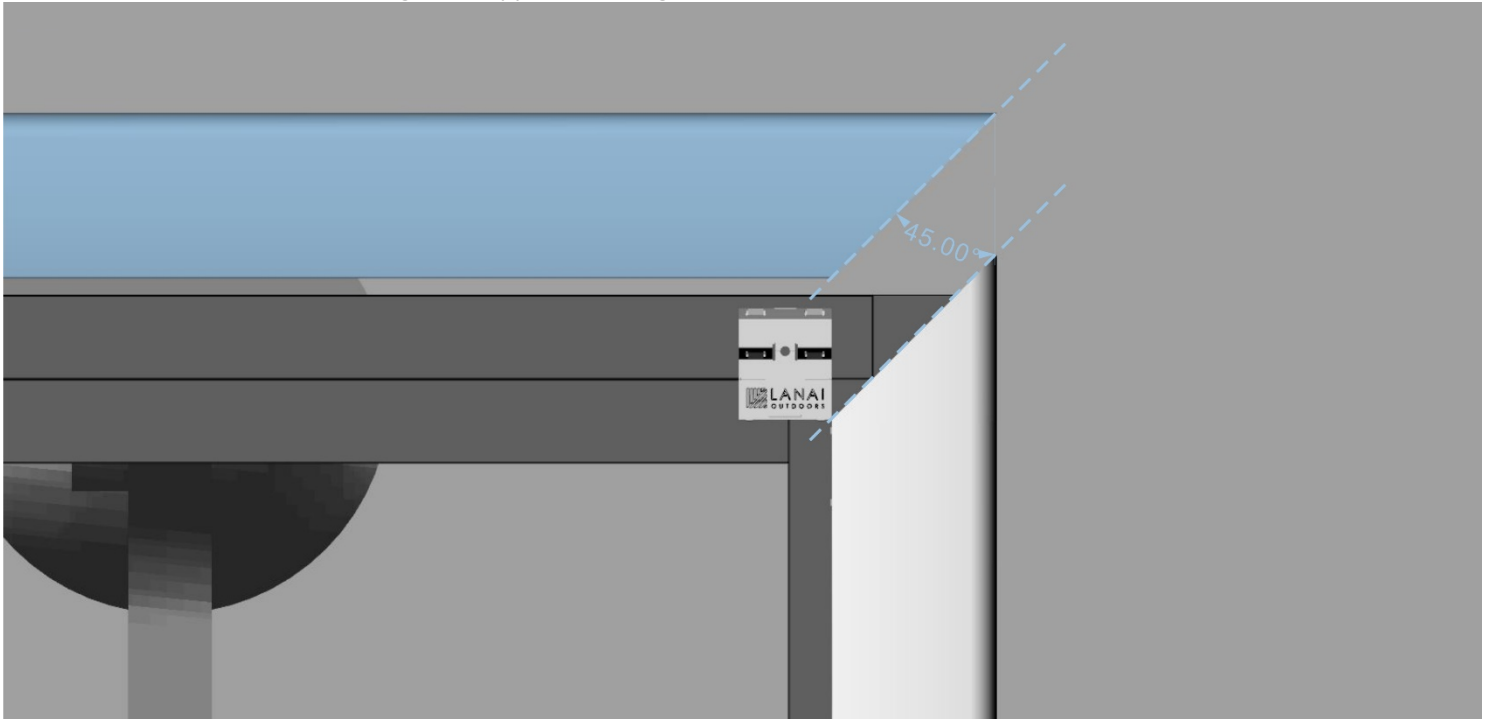

Install mitered *NOSING PLANKS* 48" down the two **Outer Side Joists**.

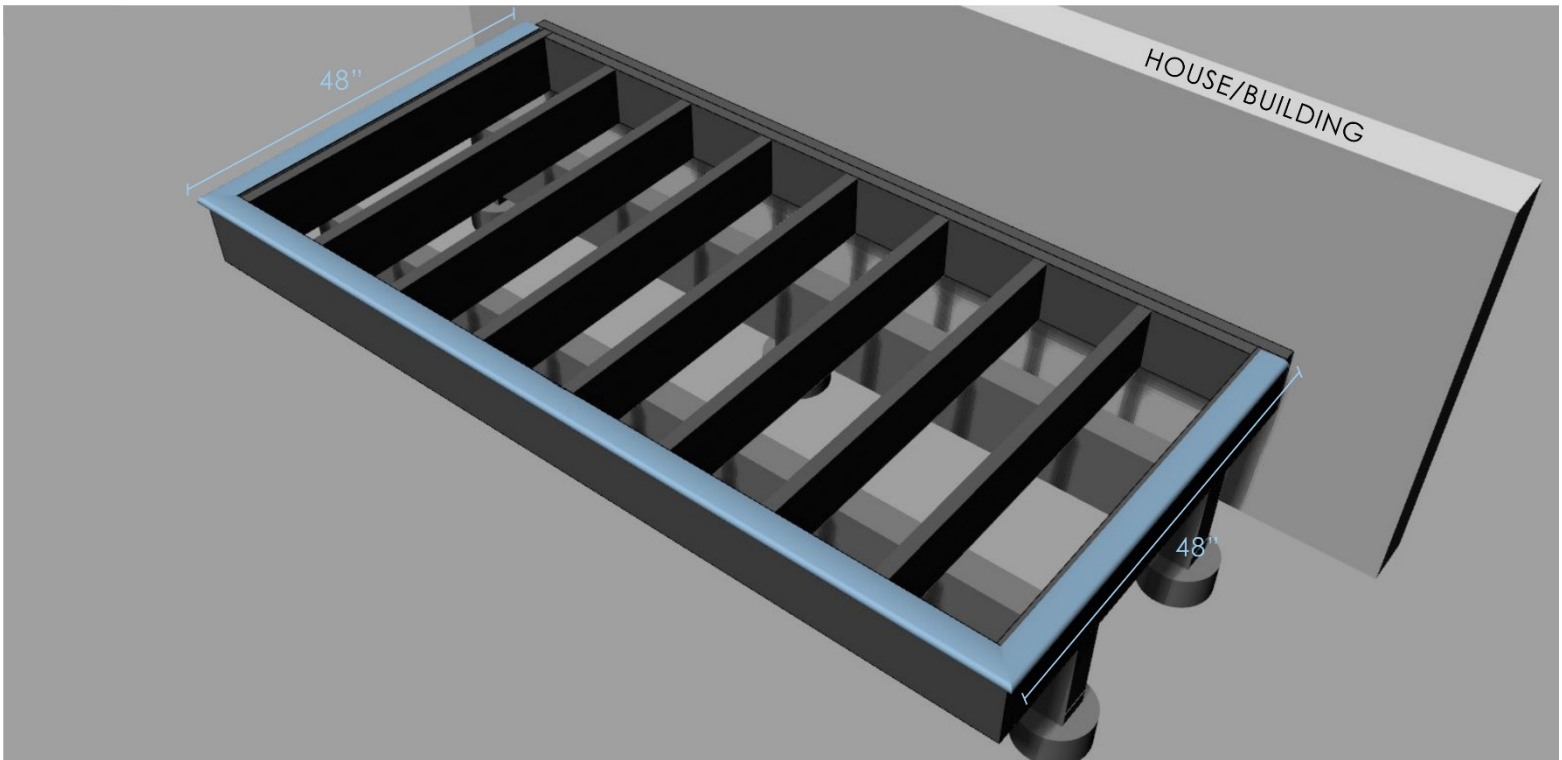

For more information, please visit our website or contact us:

www.lanaioutdoors.com * Toll Free at 1-877-477-4373 * Email at hello@lanaioutdoors.com

We want to ensure the miter is nice and tight, and the corner is square, before we begin installing *Deck Planks*. If the miter is not tight, you may have to work with the angle of the existing corner *Deck Nosing* (already installed) to create a tight fit.

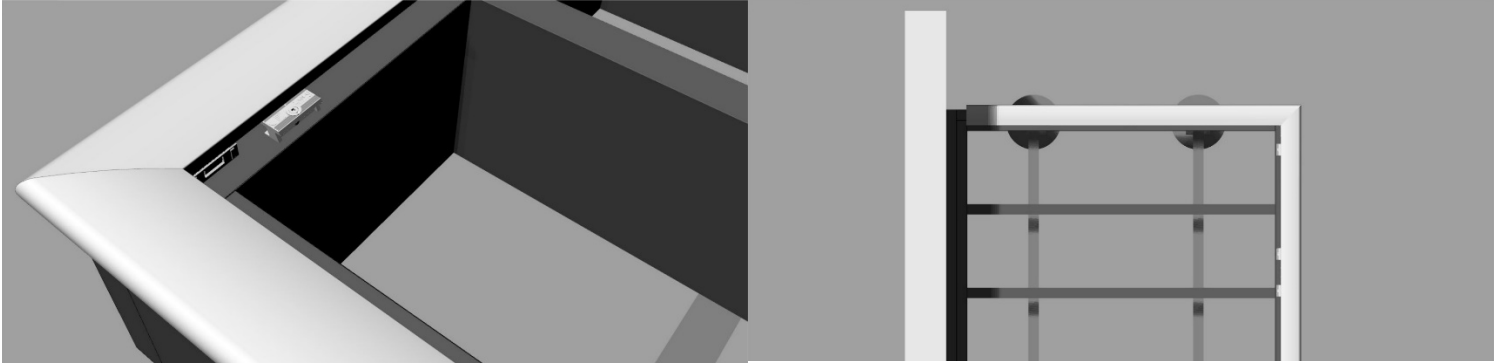

You're now ready to install some *Deck Planks*.

INSTALLING DECK PLANKS

1. First Row:
Butt the first full *Deck Plank* in the deck corner ensuring it is resting completely square against the two adjacent *Deck Nosings*.

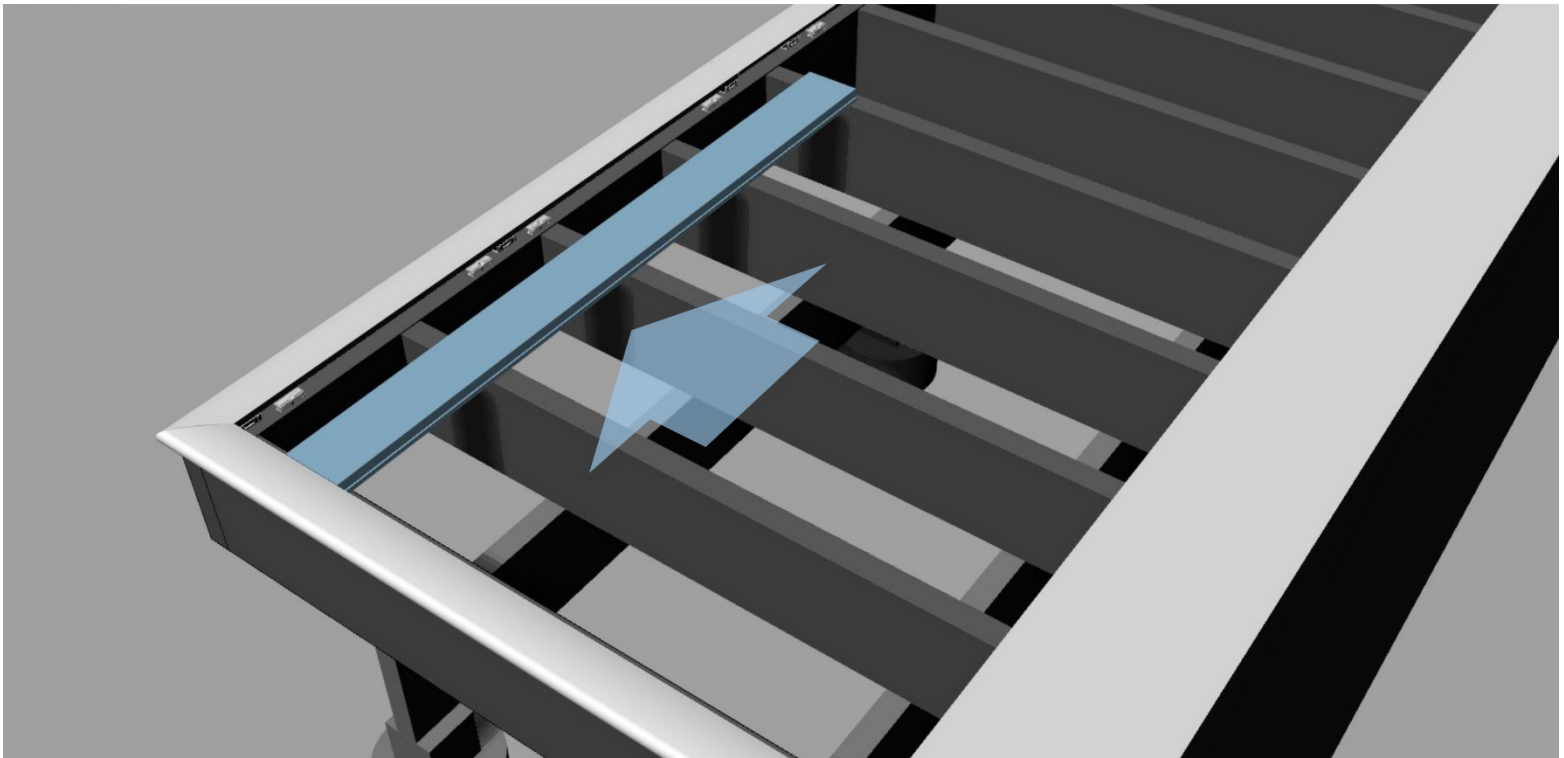

For more information, please visit our website or contact us:

www.lanaioutdoors.com * Toll Free at 1-877-477-4373 * Email at hello@lanaioutdoors.com

The groove of the *Deck Plank* should lock snugly with the Hidden Deck Fasteners on the starting row.

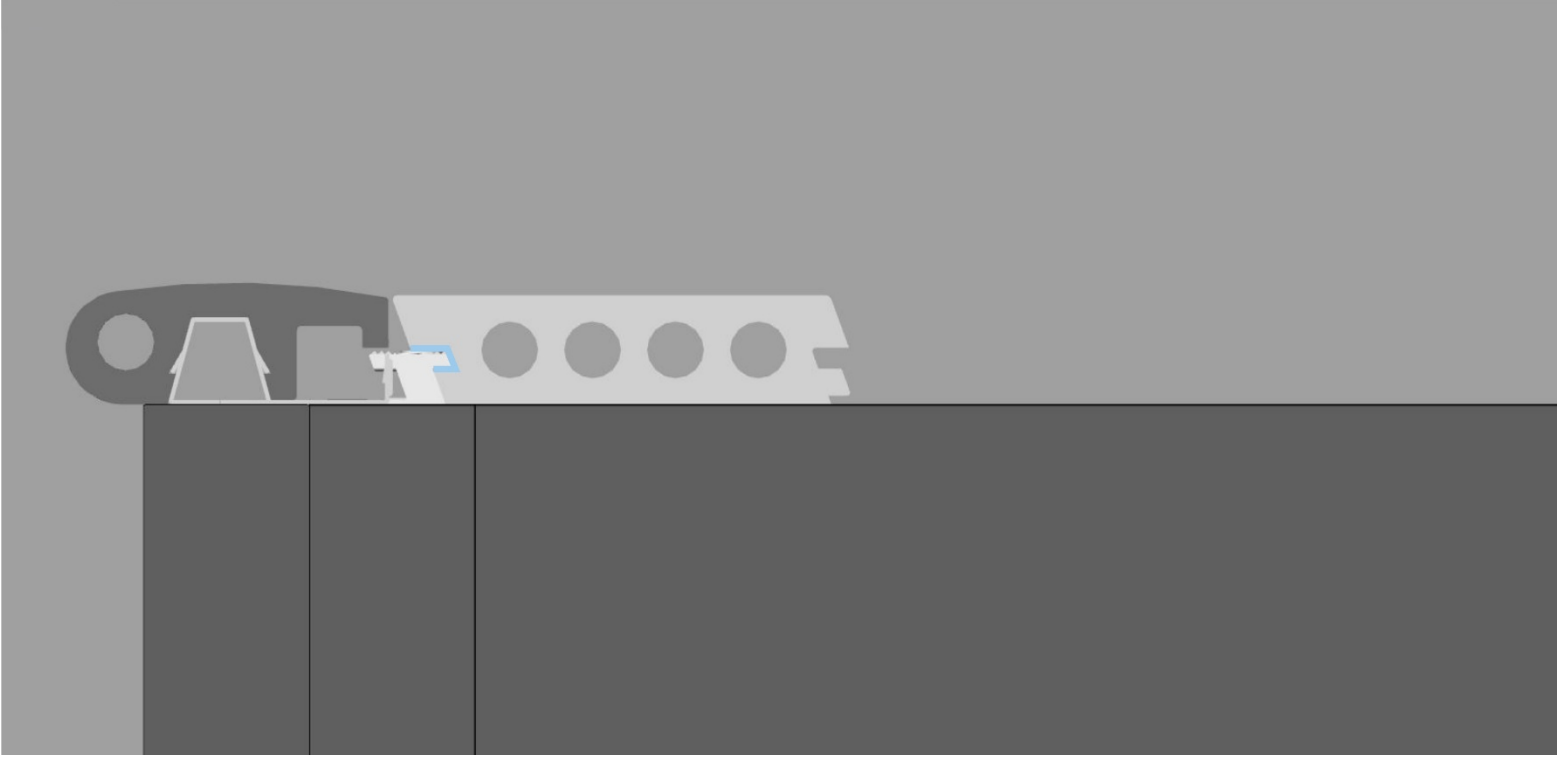

Now tap that *Deck Plank* into place using the rubber mallet.

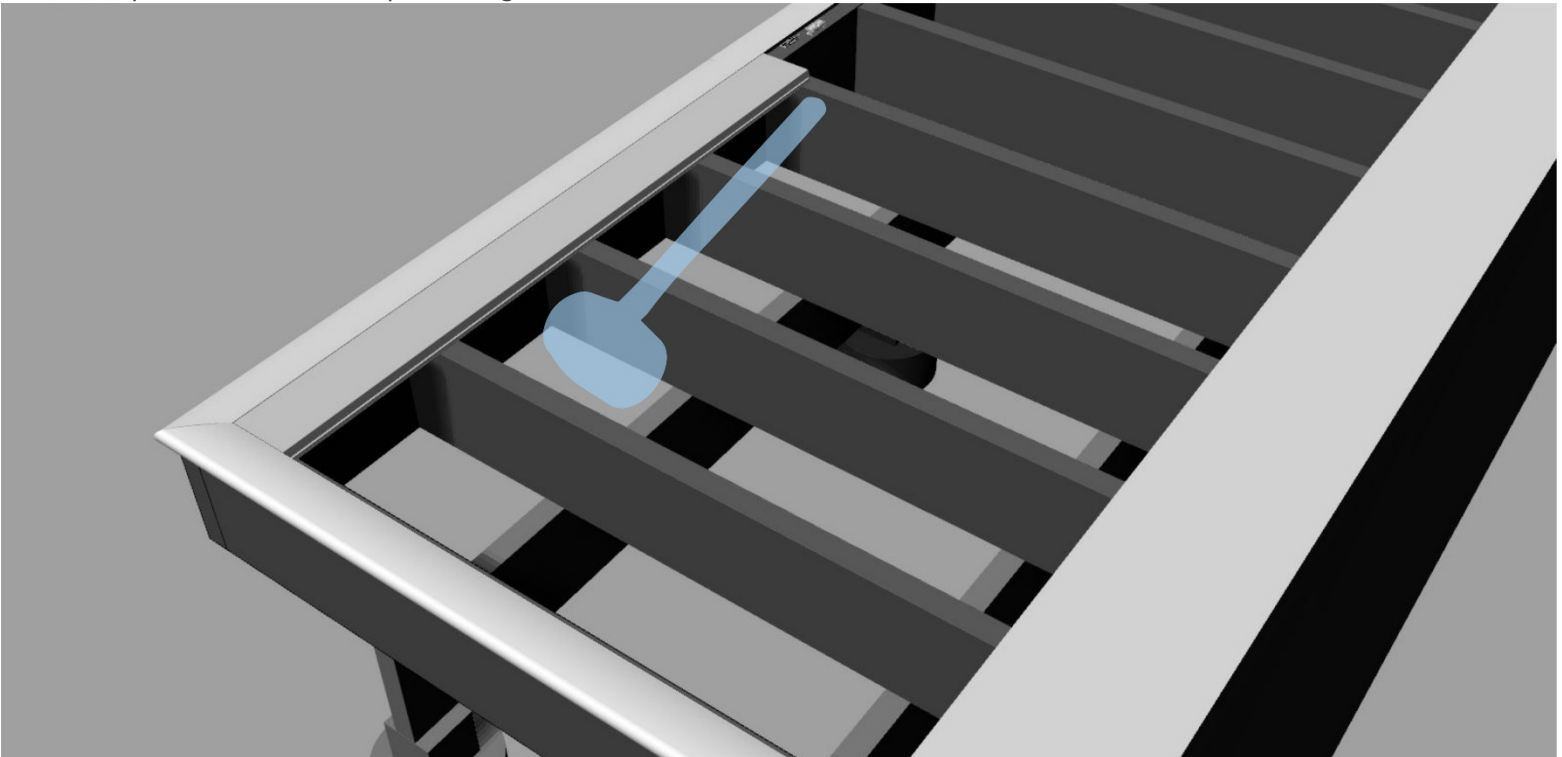

For more information, please visit our website or contact us:

www.lanaioutdoors.com * Toll Free at 1-877-477-4373 * Email at hello@lanaioutdoors.com

Continue putting the *Deck Planks* in until there is less than 48" remaining in that row. *Deck Planks* come with a slight bevel on both ends, so try to install the cut (non-bevel) edge against the side *Deck Nosing*. Ensure all *Deck Plank* ends terminate on a joist. This is necessary for support, and the *Hidden Plank Fastener* on each joist will bridge the two meeting *Deck Planks*. When a point is reached that a *Deck Plank* needs to be cut, a miter saw with a finishing blade will provide the cleanest and straightest cut. Measure the distance of the space needed to be filled. Cut the end *Deck Plank* to that length.

PRO-TIP – use a fine sanding block on the top of the cut board to add a factory matching ‘micro-bevel’

2. Secure the Other Side

Now install *Hidden Plank Fasteners* to hold the other side of the *Deck Plank*.

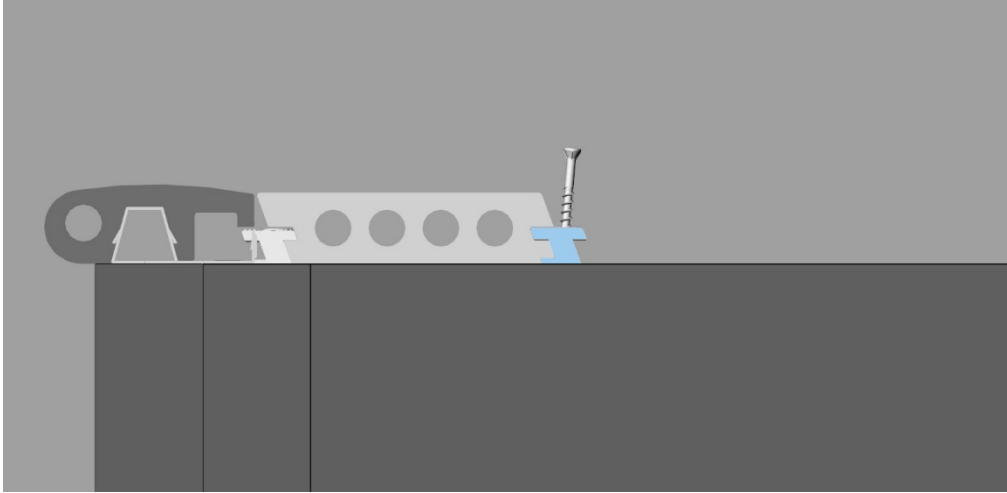

To fasten the first *Hidden Plank Fastener* on the Inner Side Joist, one of the joist-wings will need to be snapped off.

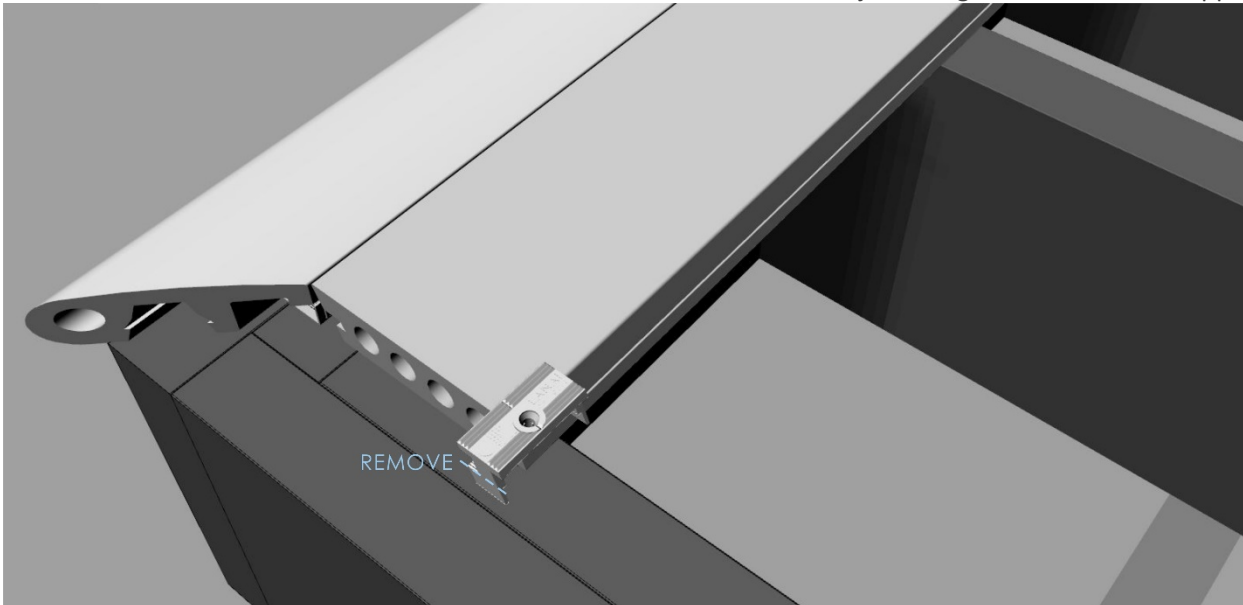

For more information, please visit our website or contact us:

www.lanaioutdoors.com * Toll Free at 1-877-477-4373 * Email at hello@lanaioutdoors.com

Place the *Hidden Plank Fasteners* joist-wing snug against the inside of the **Inner Side Joist** and slide into the groove on the other side of the first *Deck Plank*. Gently tap the *Deck Plank* and *Hidden Plank Fastener* with a rubber mallet to ensure they're seated correctly. Using a #1 square bit, screw the *Hidden Plank Fastener* screw down.

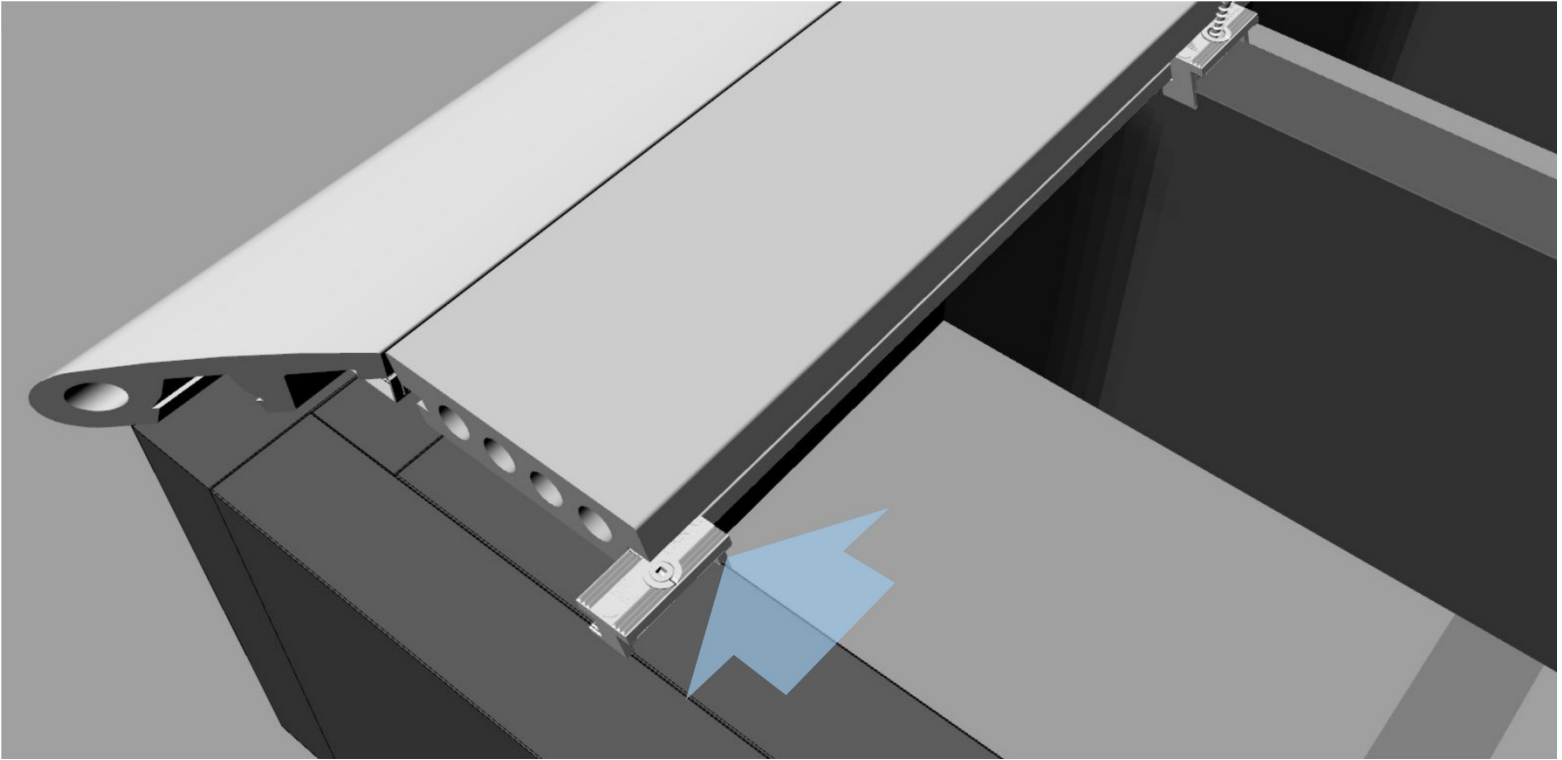

Continue applying *Hidden Plank Fasteners* in this fashion to secure the *Deck Planks* on every affected joist.

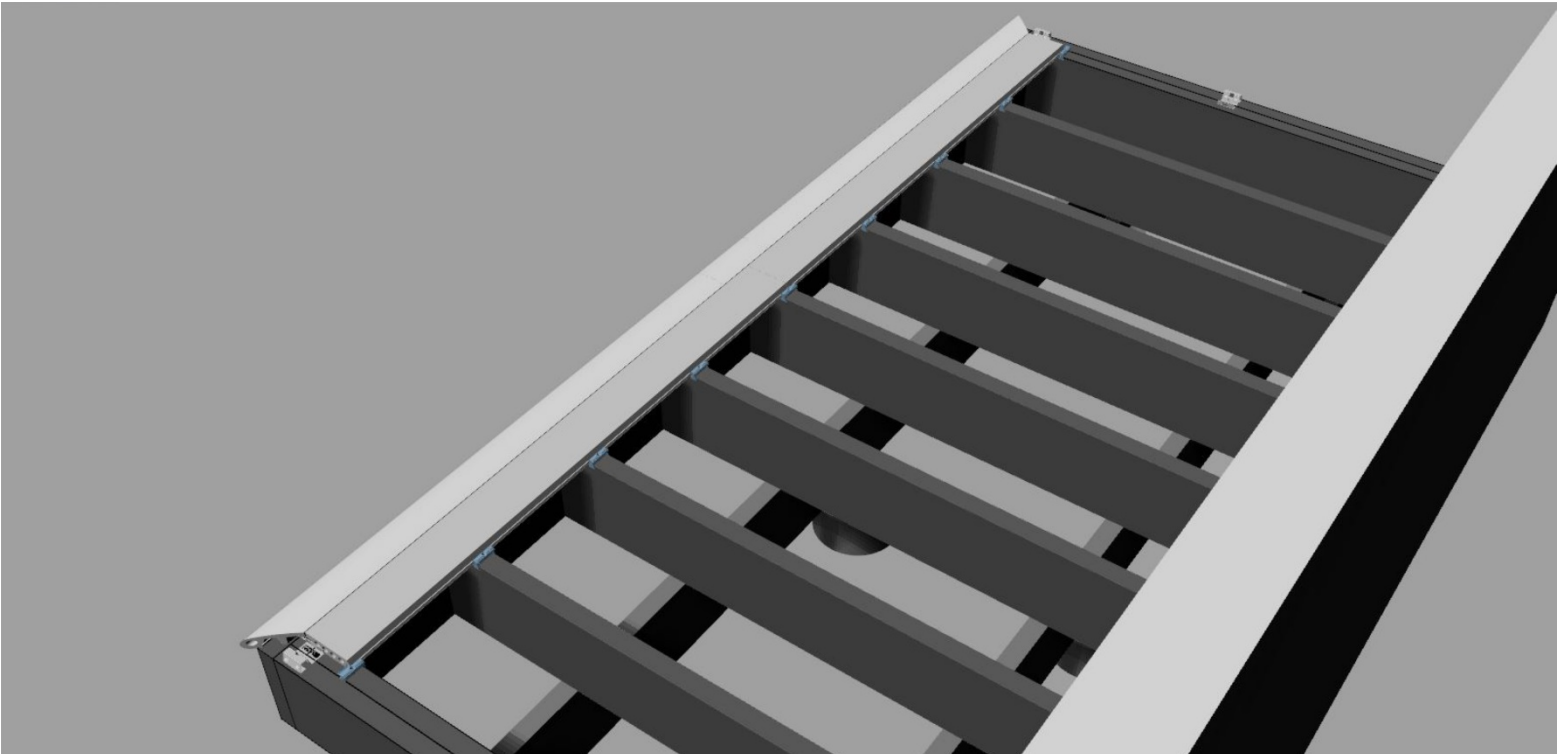

For more information, please visit our website or contact us:

www.lanaioutdoors.com * Toll Free at 1-877-477-4373 * Email at hello@lanaioutdoors.com

Next Rows:

Continue installing *Deck Plank* rows in this fashion until you reach the end of the two outside *Nosing Planks* installed. For each subsequent row, ensure to vary the *Deck Plank* length.

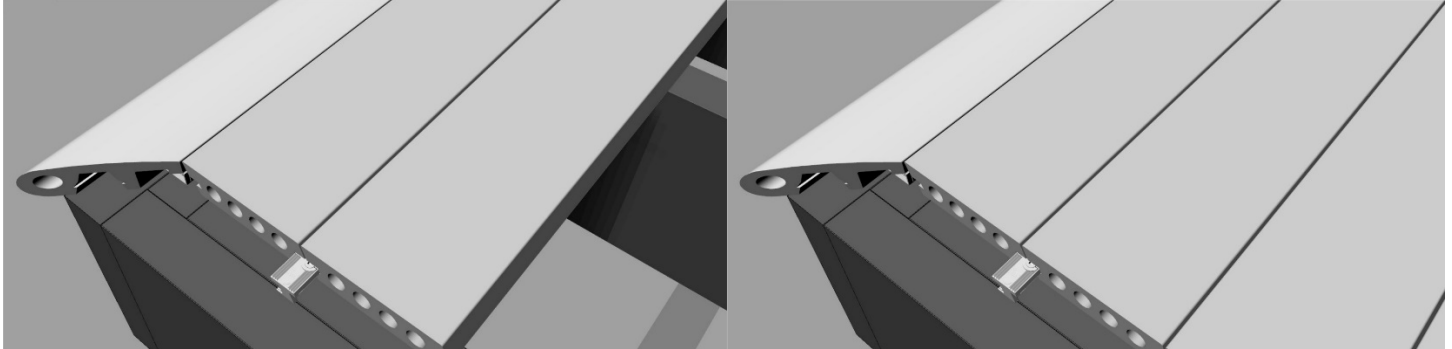

PRO TIP:

To avoid waste, use the cut piece from a previous row and cut that down to one of the usable sizes below. For the most naturally varied look, try to avoid an even stagger.

For 12" on center framing – Planks can be 12", 24", 36", and 48"

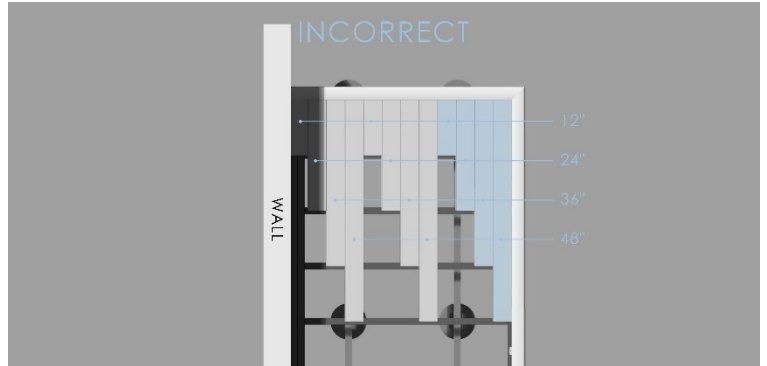
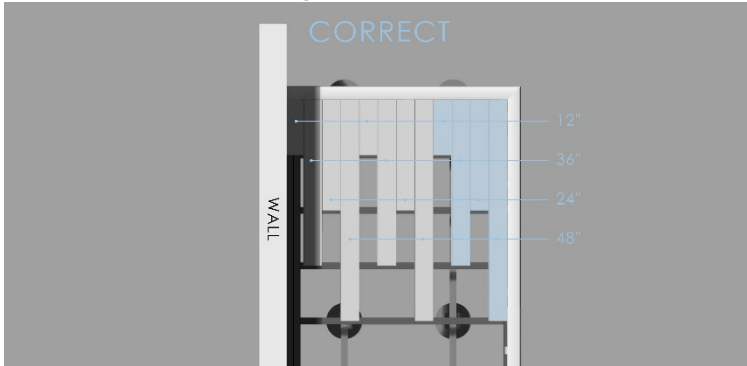

For 16" on center framing – Planks can be 16", 32", and 48"

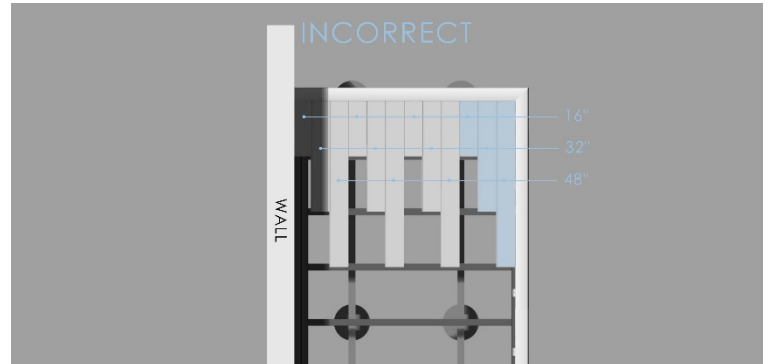
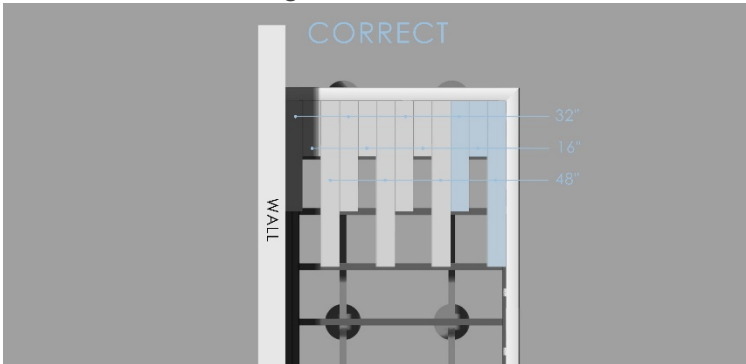

PRO-TIP – It's good practice to measure back to the wall every few courses to ensure everything is installing correctly. When your planks reach the end of your single nosing pieces installed on either Outer Side Joists, stop and assess.

For more information, please visit our website or contact us:

www.lanaioutdoors.com * Toll Free at 1-877-477-4373 * Email at hello@lanaioutdoors.com

If everything is square and looks correct, finish installing the *Deck Nosing* on both sides, leaving about a $\frac{1}{4}$ " gap between the final *Deck Nosing* and the wall.

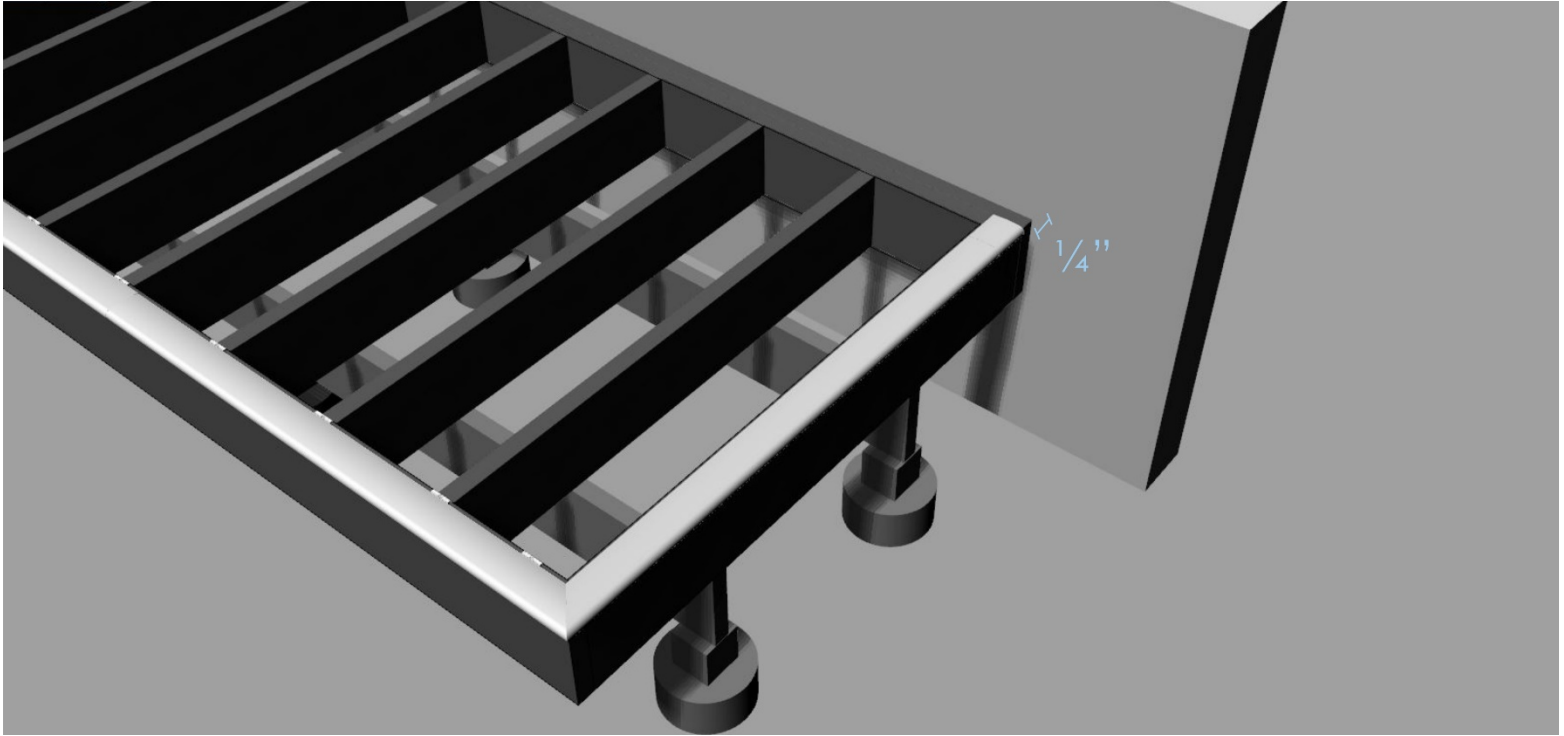

Now continue to install all rows of *Deck Planks* until you are less than 4" away from the wall.

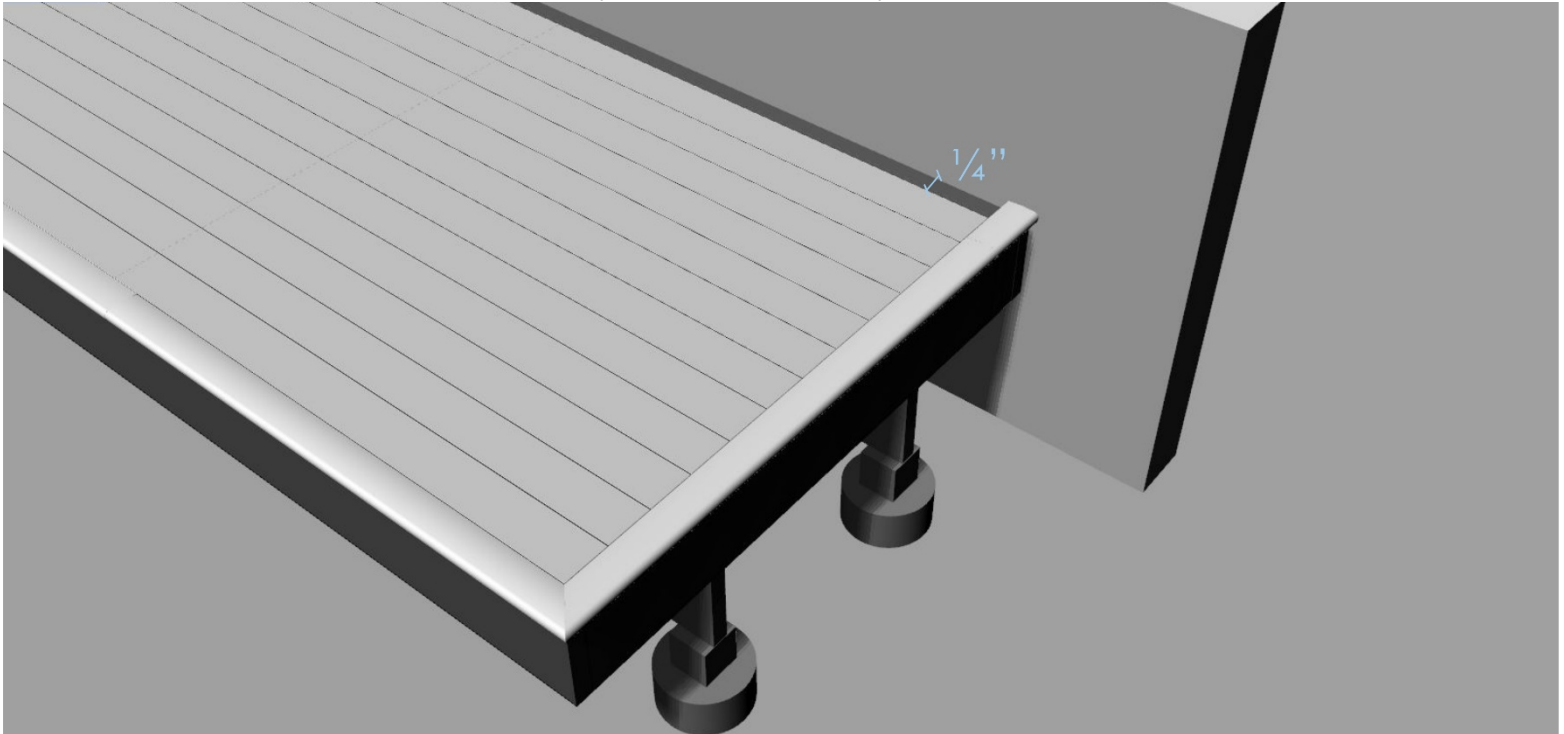

For more information, please visit our website or contact us:

www.lanaioutdoors.com * Toll Free at 1-877-477-4373 * Email at hello@lanaioutdoors.com

3. Final Row:

For most installations, a full *Deck Plank* will not fit as the final row (against the wall). If it works out perfectly that about 4" is remaining, then you can use a full *Deck Plank*. If the fit is too tight, you may need to cut off the angled bevel on the side of the plank facing the house/building.

If there is less than 4" remaining, measure the space remaining and subtract 1/8". Measure, mark, and cut the *Deck Plank* lengthwise to fit. These should be dry-fit first and then glued down as only the one side will have a groove to fit into the *Hidden Plank Fastener* from the previous row.

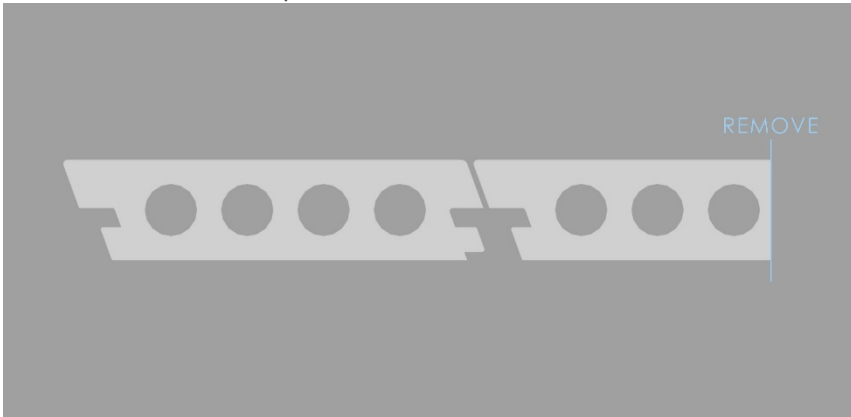

Apply adhesive in along the center of the 1-2 **Wall Joists** that are exposed. Then install the *Deck Plank* and apply light pressure to ensure a level finish. We recommend using Titebond TiteGrab, or an equivalent 'heavy duty construction adhesive'.

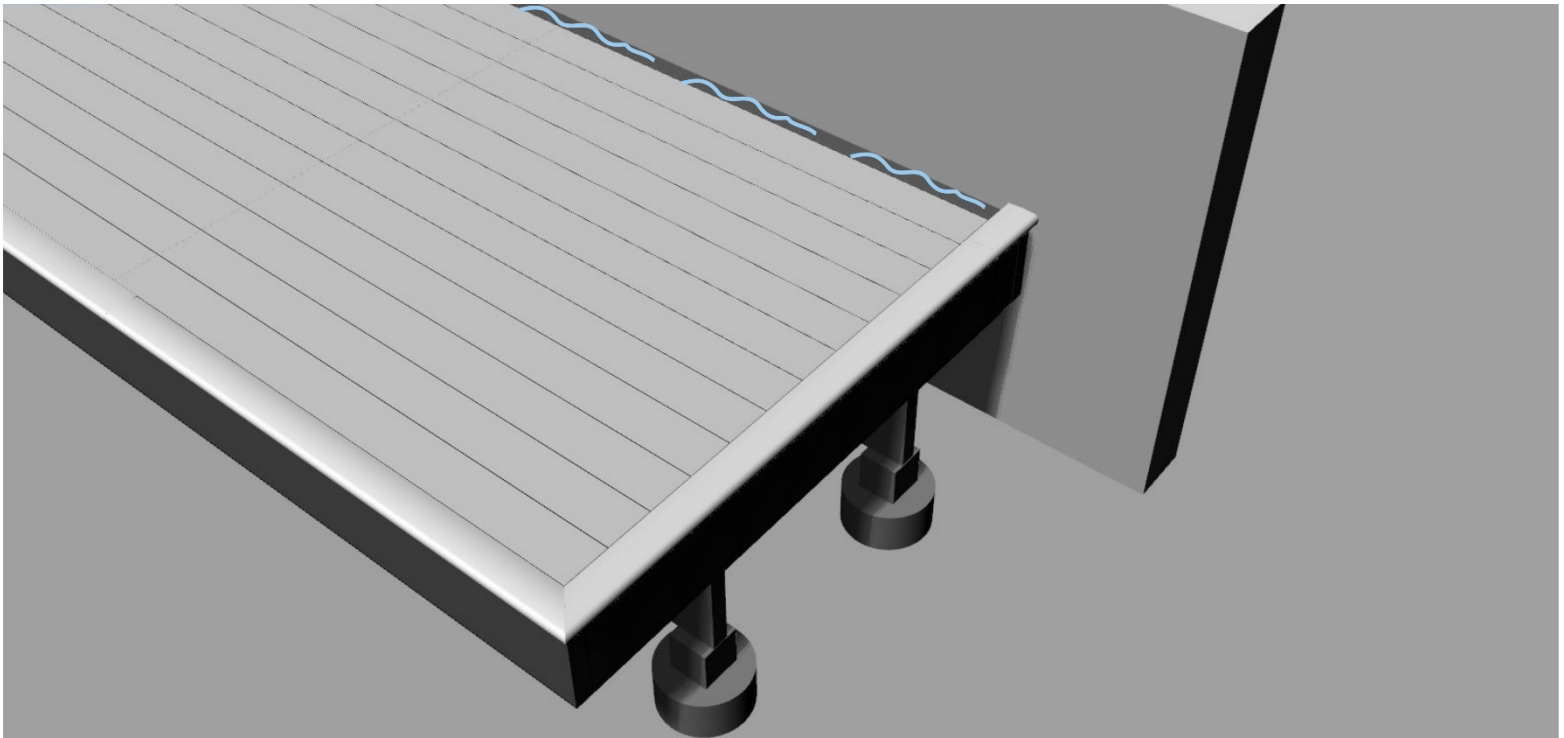

For more information, please visit our website or contact us:

www.lanaioutdoors.com * Toll Free at 1-877-477-4373 * Email at hello@lanaioutdoors.com

Narrow Planks Installation

Narrow Planks can be used for the entire deck installation for a spectacular look or used in combination with *Deck Planks* to add a varied look. Installation of *Narrow Planks* is the same as *Deck Planks*. It is important to note that due to pieces being half as wide, twice as many *Hidden Plank Fasteners* are needed when installing *Narrow Planks* for the same deck area.

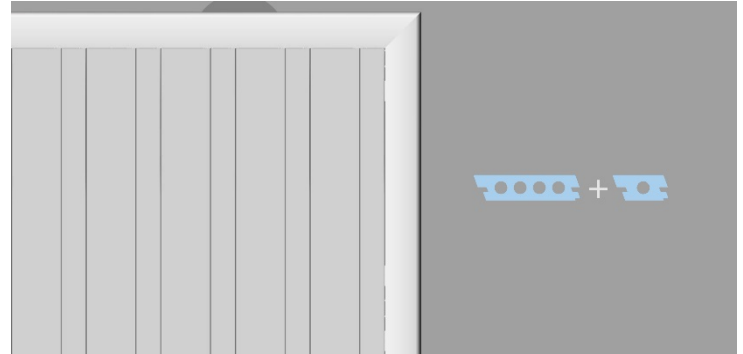
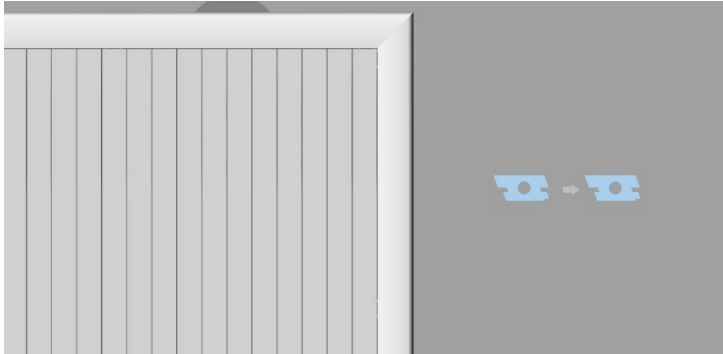

Deck Fascia Installation

We recommend mitered corners for the Deck Fascia and trying to have the seams match the seams of the *Deck Nosing* above. This provides the cleanest and most continuous look. To achieve this, start at an outside corner. Measure the distance from the seam on the *Deck Nosing* to the edge of the deck. Add $\frac{1}{4}$ " (fascia thickness) to that measurement and mark that distance to the frontside of the *Deck Fascia*. Cut a 45-degree corner (cut at an angle that will create a longer measurement on the face) at the edge of the *Deck Fascia* that will be at the edge of the deck.

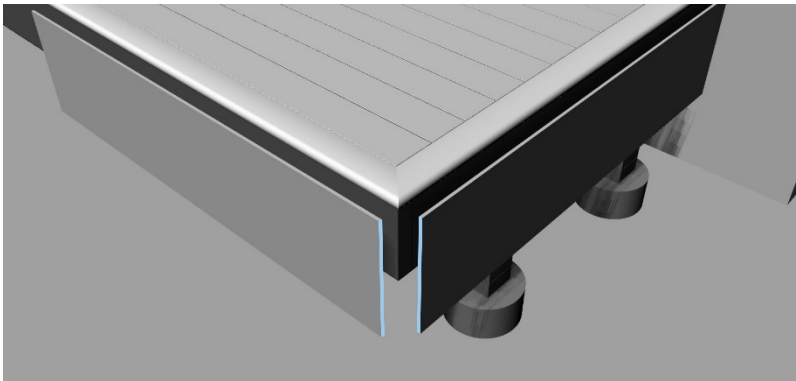

Now it is time to fasten the first piece, using one of two methods:

Adhesive:

This is our recommended method, as it provides the cleanest look. Once the *Deck Fascia* is ready to install, ensure that all dust and debris is wiped off the back of the Fascia and the Joist you are adhering to. Then apply a continuous bead of construction adhesive to the back of the *Deck Fascia* 1-2" from the 4 edges of the back (smooth side), and then in a serpentine shape in the middle. Then put in place and apply pressure across all areas of the *Deck Fascia* adequate spreading of the adhesive. Painter's tape or appropriate clamps can be used to help keep the *Deck Fascia* in place while it sets.

For more information, please visit our website or contact us:

www.lanaioutdoors.com * Toll Free at 1-877-477-4373 * Email at hello@lanaioutdoors.com

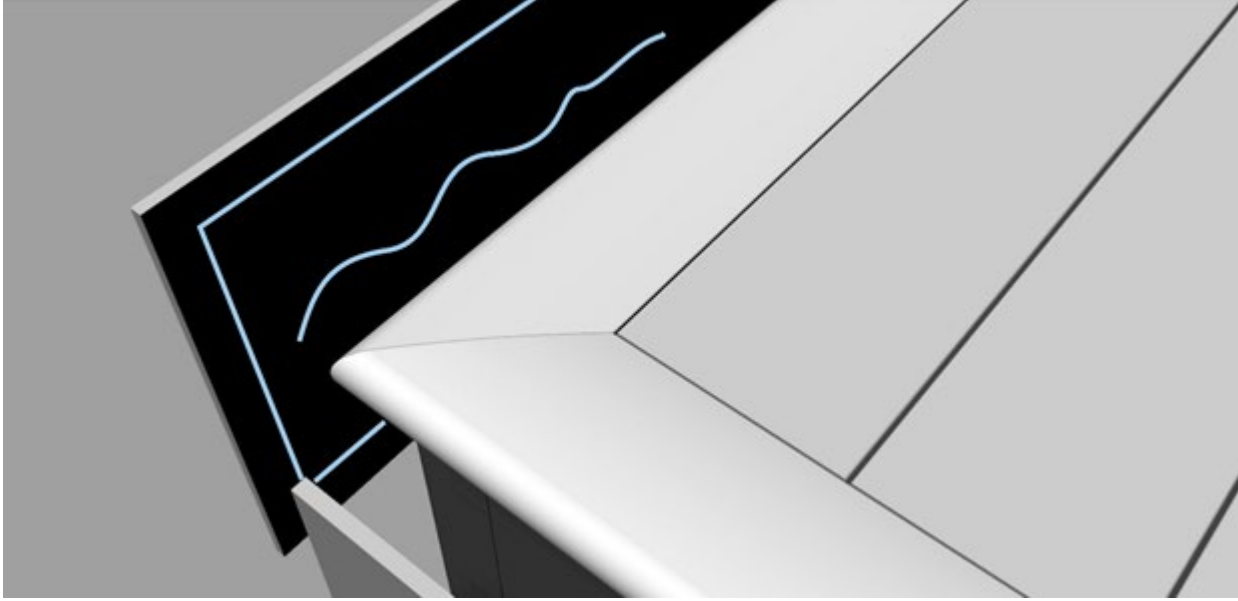

Screws:

Use the recommended color-matched FastenMaster TrapEase fascia screw kit and instructions.

Beach Wood – Beach Dune recommended

Sunset Palm – Saddle recommended

Dark Kona – Lava Rock recommended

Black Sand – Woodland Brown recommended

You will pre-drill holes using the Counterbore Tool, and then fasten screws using the Driver Bit.

Starting at the edge, install screws 1" from the corner and then every 12", with three screws across the face at each interval.

Once there is less than 48" remaining to cover, measure and cut the final Deck Fascia. If it is butting up to a house/building, simply measure the distance remaining and mark the Deck Fascia on the face for that cut. If it is going to be another mitered corner, make the 45-degree cut as per the instructions used above for the first Deck Fascia.

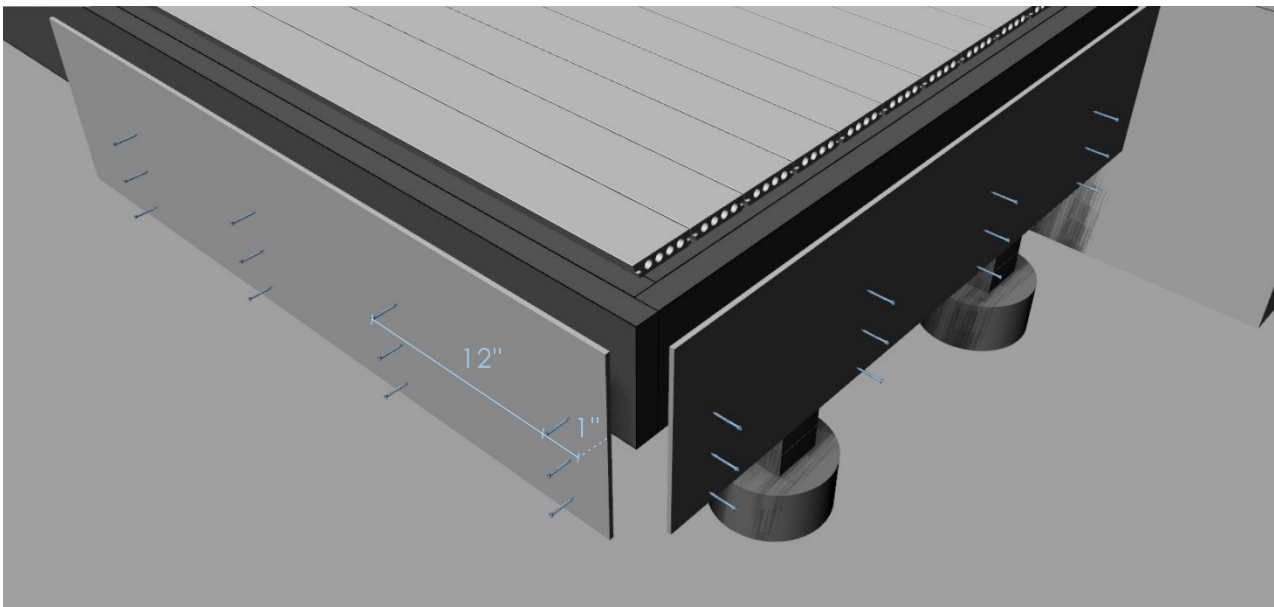

For more information, please visit our website or contact us:

www.lanaioutdoors.com * Toll Free at 1-877-477-4373 * Email at hello@lanaioutdoors.com

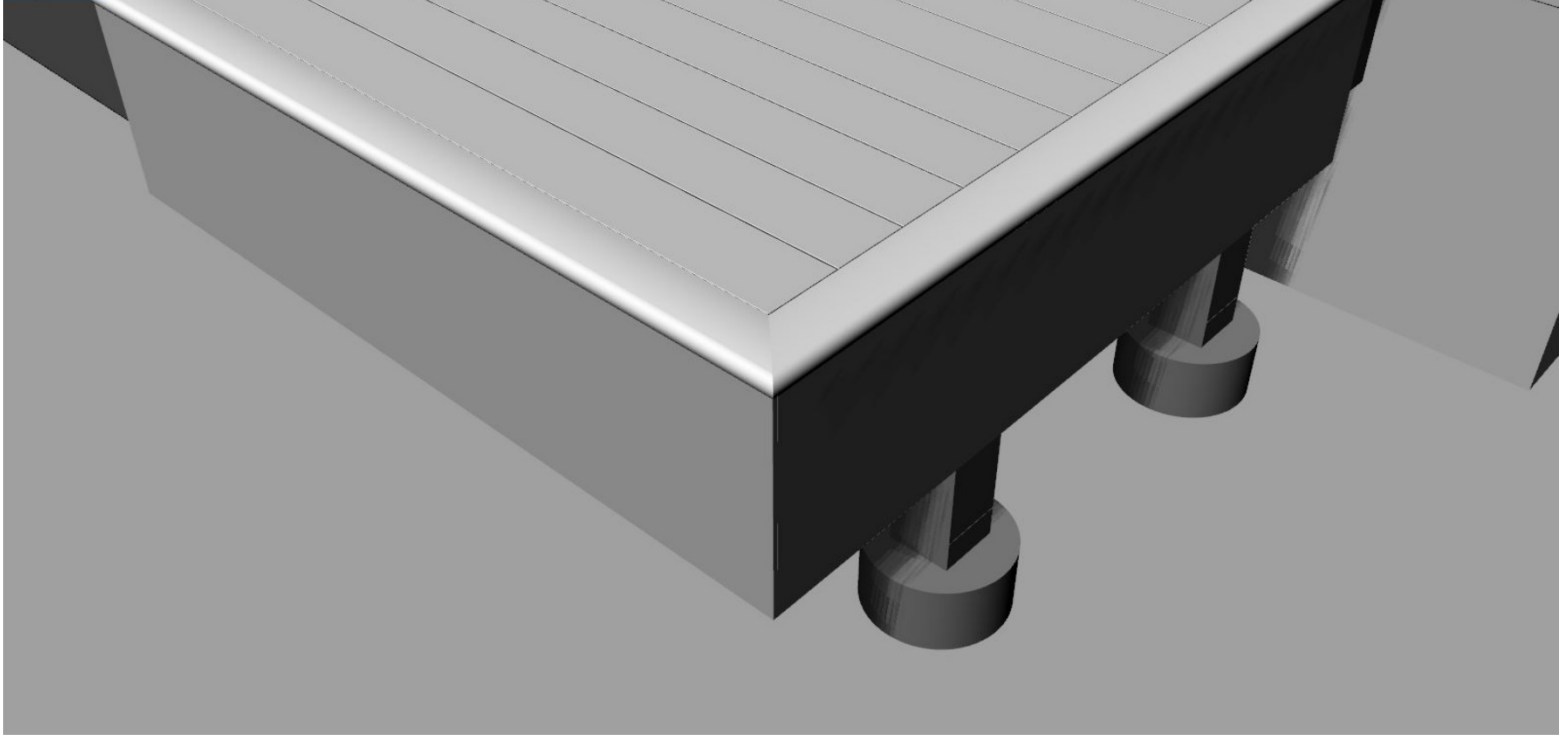
**INSTALL TEMPERATURES:**

In temperatures at or below 50°F (10°C), leave 3/16 in. (4.8 mm) space between the outside *Deck Plank* ends and the *Deck Nosing*.
In temperatures above 50°F (10°C), install with 1/8 in. (3.2 mm) space between the outside *Deck Plank* ends and the *Deck Nosing*.

NOTE:

Construction methods are always improving, and code is subject to change. Please go to lanaioutdoors.com/installation for the most up-to-date Installation Instructions, and please ensure you are following updated code regulations.

DISCLAIMER:

LANAI OUTDOORS INC. (LANAI) does not install or have any control over how product is installed, therefore these Instructions are to be used as only as guidelines. LANAI assumes no liability for improper installation or personal injury resulting from proper or improper use or installation

For more information, please visit our website or contact us:

www.lanaioutdoors.com * Toll Free at 1-877-477-4373 * Email at hello@lanaioutdoors.com